

Helical Spiral Antenna 12dBi Typ. Gain, 1.95-2.1 GHz  
Frequency Range

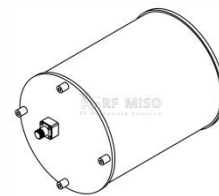

## Helical Spiral Antenna Data Sheet

**RM-HSA1921-12R**

### Description

RM-HSA1921-12R is a right hand circular polarization(RHCP) helical spiral antenna, operating from 1.95 to 2.1GHz with a 12dB Typ. gain and low VSWR 1.5:1 with N Female . It has high gain, simple structure, and compact size, along with right-hand circular polarization, make it ideal for reflector feeding, antenna measurement, and other applications.

### Specification

RM-HSA1921-12R		
Parameters	Typical	Units
Frequency Range	1.95-2.1	GHz
Impedance	50	ohms
Gain	12 Typ.	dBi
VSWR	1.5 Typ.	
Polarization	RH circular	
Axial Ratio	<2	dB
Cross Polarization	22 Typ.	dB
Connector	N-Female	
Size	Ø212.0 * 273.0(±5)	mm
Weight	2.597	Kg
Power Handling(cw)	300	w
Power Handling(peak)	500	w

Helical Spiral Antenna 12dBi Typ. Gain, 1.95-2.1 GHz  
Frequency Range

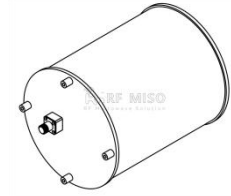

**Helical Spiral Antenna Data Sheet**

**RM-HSA1921-12R**

**Outline Drawing**

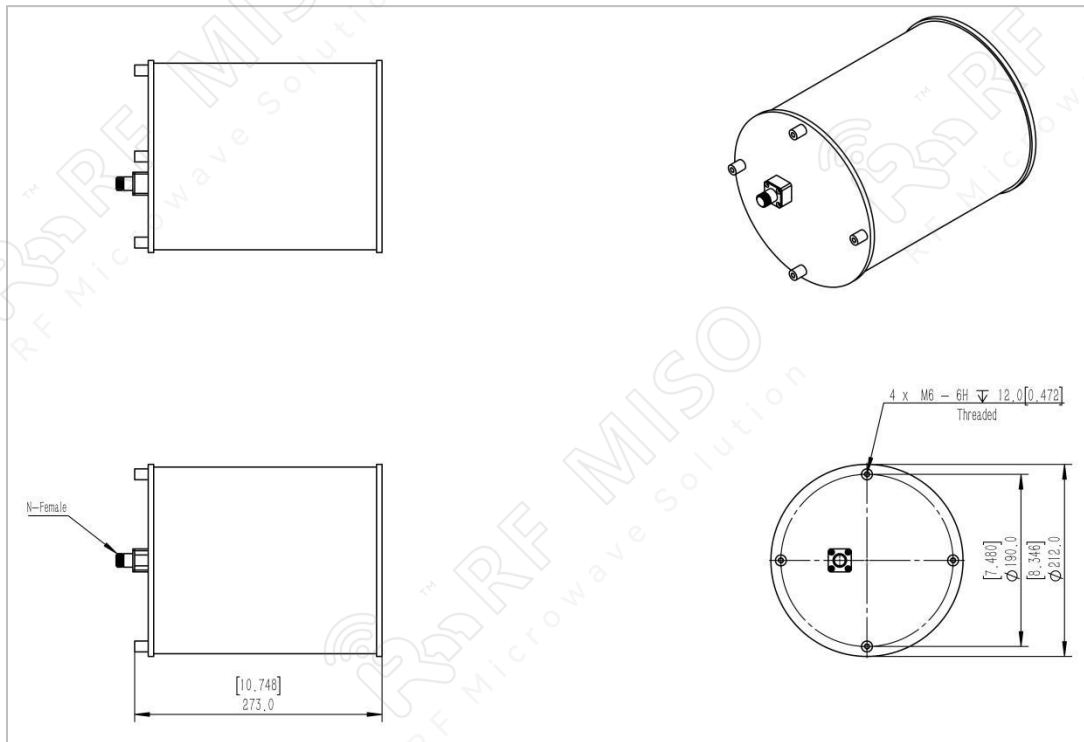

Helical Spiral Antenna 12dBi Typ. Gain, 1.95-2.1 GHz  
Frequency Range

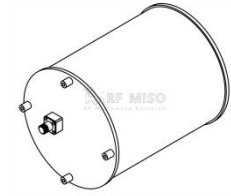

**Helical Spiral Antenna Data Sheet**

**RM-HSA1921-12R**

**Simulation Results**

**VSWR**

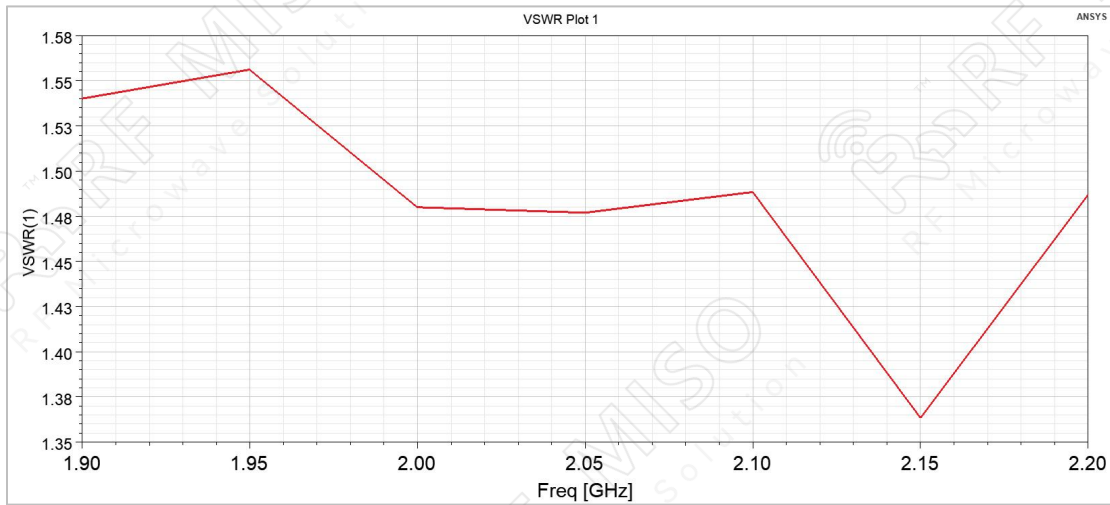

**Gain**

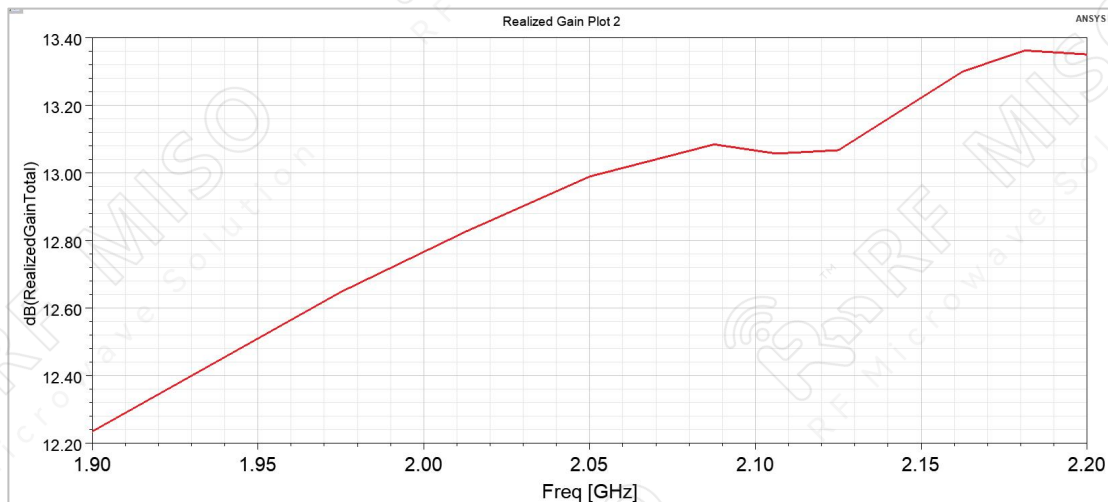

Helical Spiral Antenna 12dBi Typ. Gain, 1.95-2.1 GHz  
Frequency Range

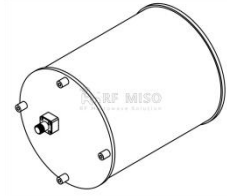

**Helical Spiral Antenna Data Sheet**

**RM-HSA1921-12R**

**Cross Polarization**

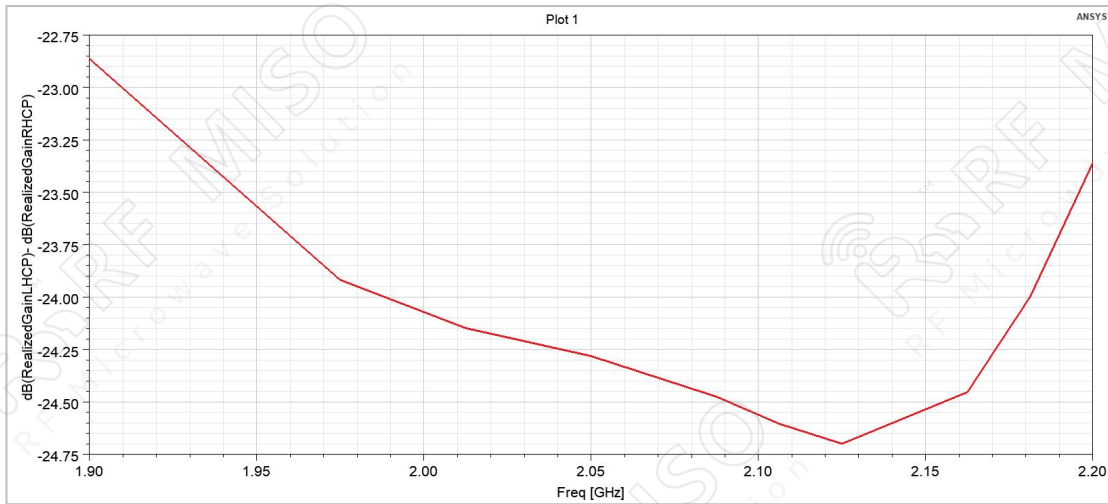

**Radiation Pattern**

1.9 GHz:

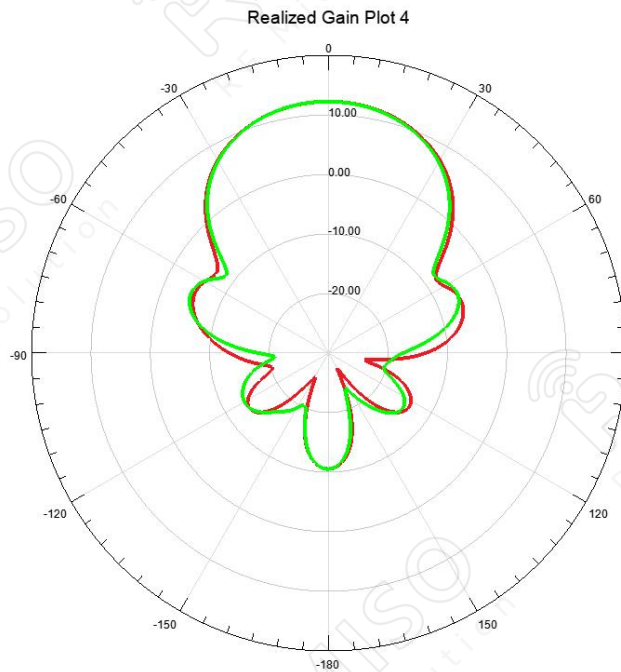

Helical Spiral Antenna 12dBi Typ. Gain, 1.95-2.1 GHz  
Frequency Range

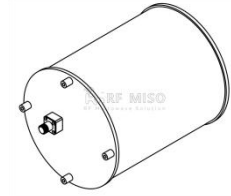

**Helical Spiral Antenna Data Sheet**

**RM-HSA1921-12R**

2.0125GHz:

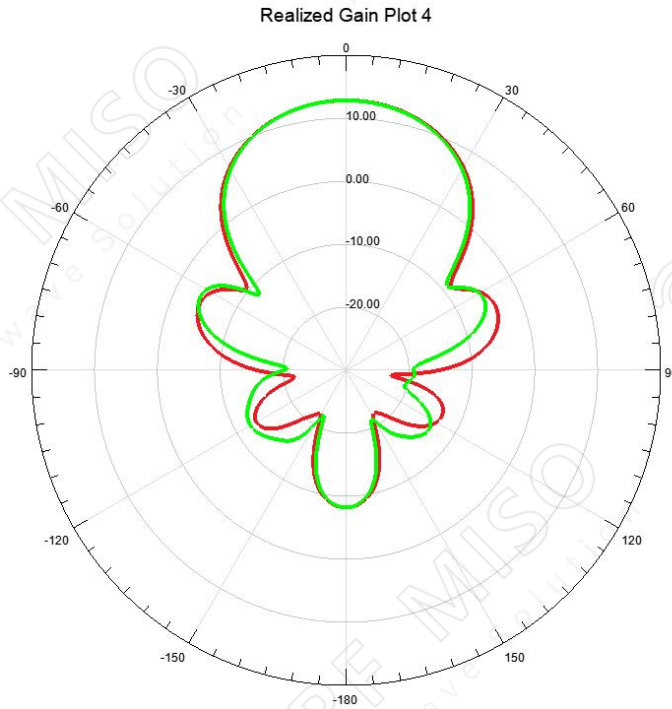

2.05GHz:

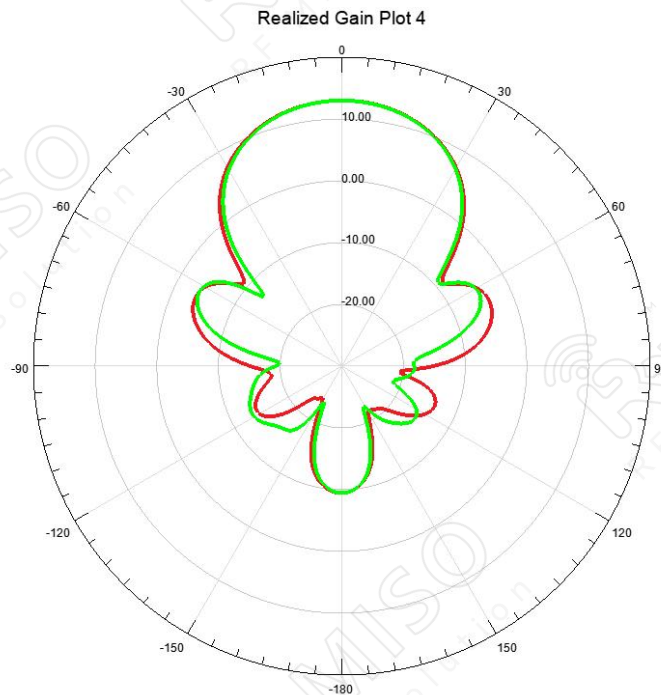

Helical Spiral Antenna 12dBi Typ. Gain, 1.95-2.1 GHz  
Frequency Range

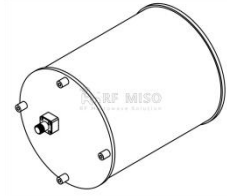

**Helical Spiral Antenna Data Sheet**

**RM-HSA1921-12R**

2.2GHz:

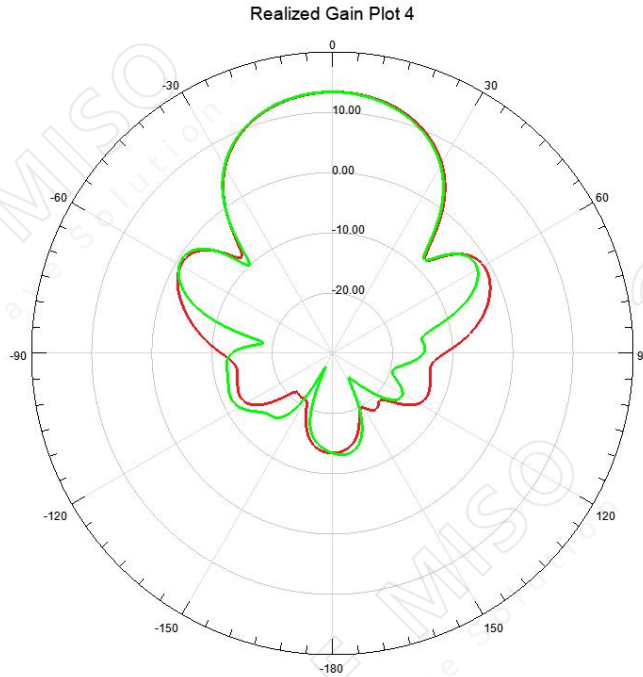

**3dB Beamwidth\_E-Plane**

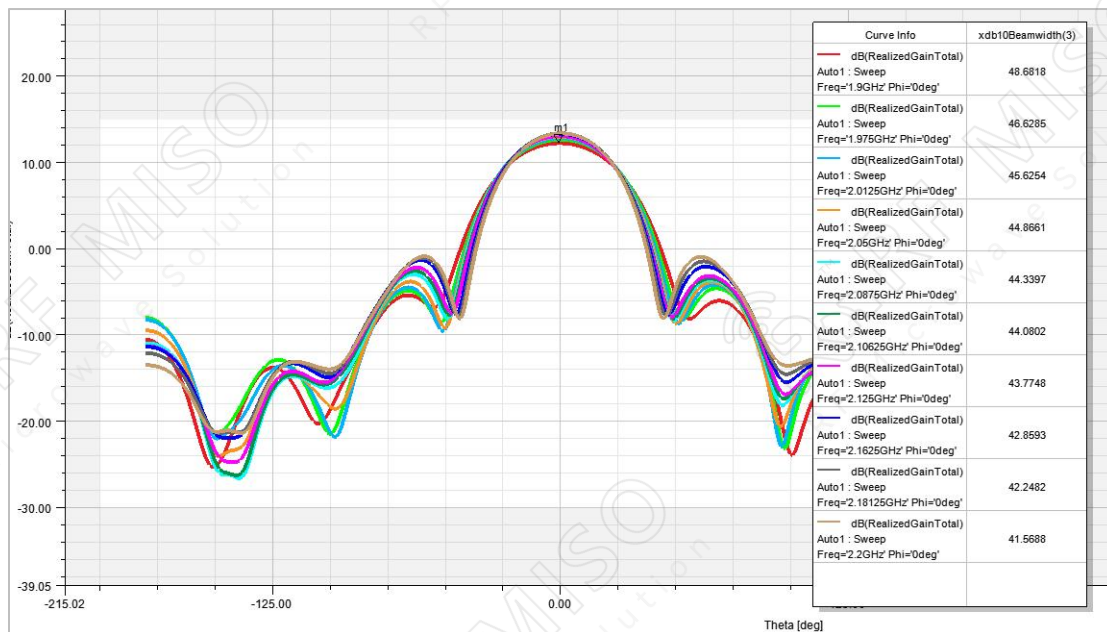

Helical Spiral Antenna 12dBi Typ. Gain, 1.95-2.1 GHz  
Frequency Range

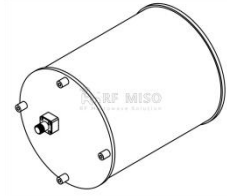

**Helical Spiral Antenna Data Sheet**

**RM-HSA1921-12R**

**3dB Beamwidth\_H-Plane**

