

*Dual Circular Polarization Horn Antenna  
15 dBi Typ. Gain, 27-32 GHz Frequency Range*

## Dual Circular Polarized Horn Antenna Data Sheet

**RM-DCPHA2732-15**

### Features

- Small Size
- Low VSWR
- Good Orientation
- Dual Circular

### Descriptions

RF MISO's **Model RM-DCPHA2732-15** is a dual circular polarized horn antenna that operates from 27 to 32 GHz, The antenna offers 15dBi typical gain. The antenna VSWR is typical 1.3:1. The antenna RF ports are waveguide and a coaxial converter can be added, the interface is 2.92 female. The antenna can be widely used in EMI detection, orientation, reconnaissance, antenna gain and pattern measurement and other application fields.

### Specifications

RM-DCPHA2732-15		
Parameters	Typical	Units
Frequency Range	27-32	GHz
Gain	15 Typ.	dBi
VSWR	1.3 Typ.	
Polarization	Dual circular	
Axial Ratio	0.5 Typ.	dB
F/B	50 Typ.	dB
Coaxial Interface	2.92-Female	
Material	Al	
Finishing	Paint	
Size (L*W*H)	104.64*56*56(±5)	mm
Weight	0.105	Kg

Dual Circular Polarization Horn Antenna  
15 dBi Typ. Gain, 27-32 GHz Frequency Range

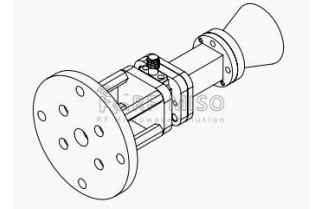

**Dual Circular Polarized Horn Antenna Data Sheet**

**RM-DCPHA2732-15**

**Outline Drawing**

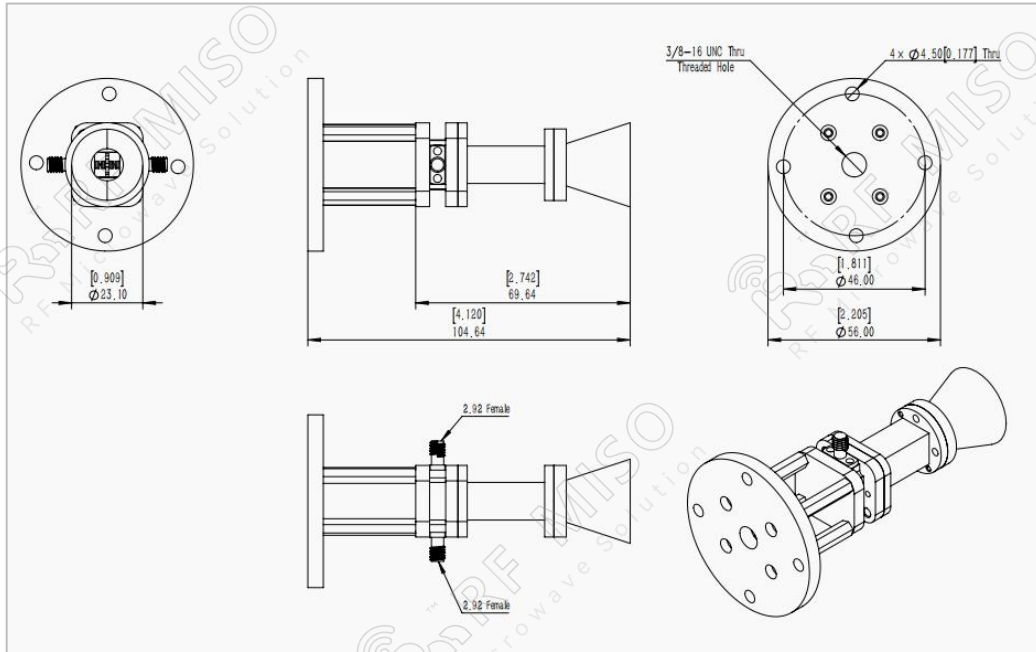

**Simulation Data**

**Gain**

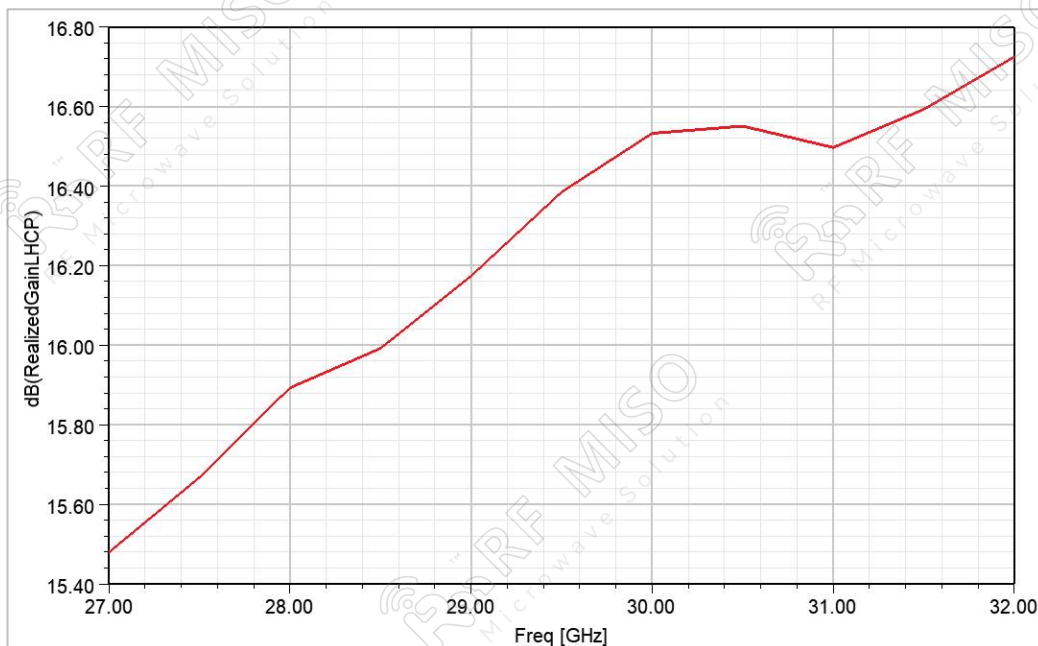

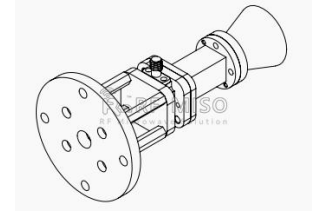

Dual Circular Polarization Horn Antenna  
15 dBi Typ. Gain, 27-32 GHz Frequency Range

**Dual Circular Polarized Horn Antenna Data Sheet**

**RM-DCPHA2732-15**

VSWR

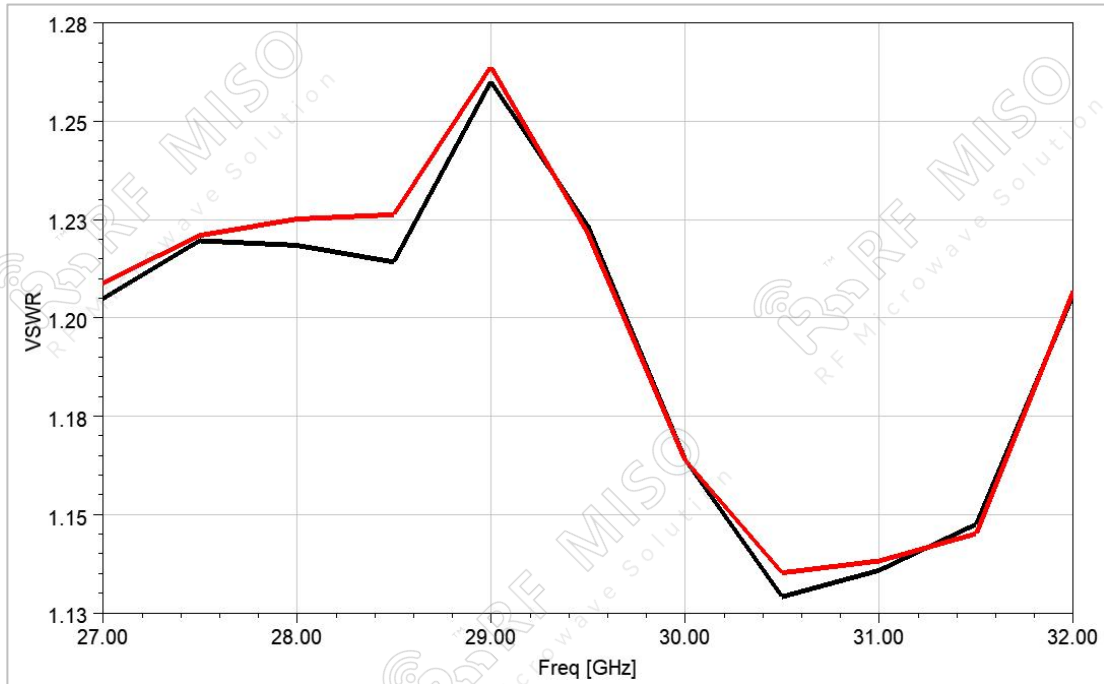

Axial Ratio

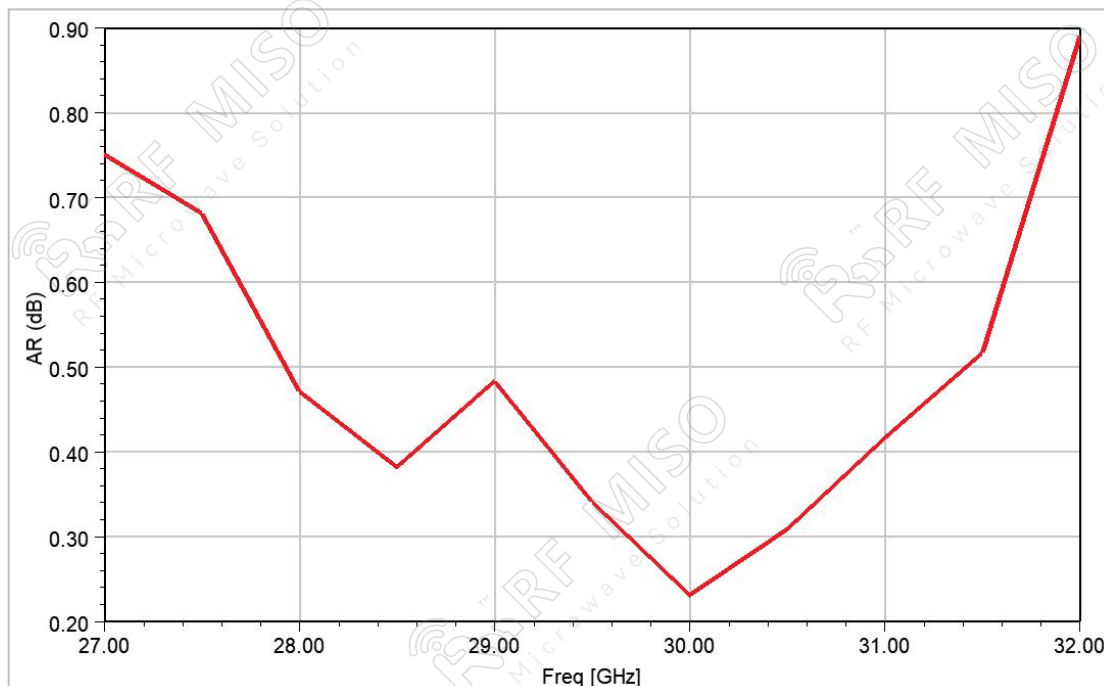

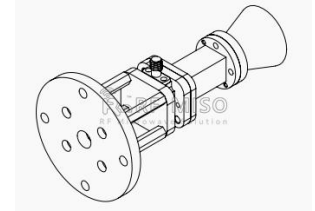

Dual Circular Polarization Horn Antenna  
15 dBi Typ. Gain, 27-32 GHz Frequency Range

**Dual Circular Polarized Horn Antenna Data Sheet**

**RM-DCPHA2732-15**

Port-to-port isolation

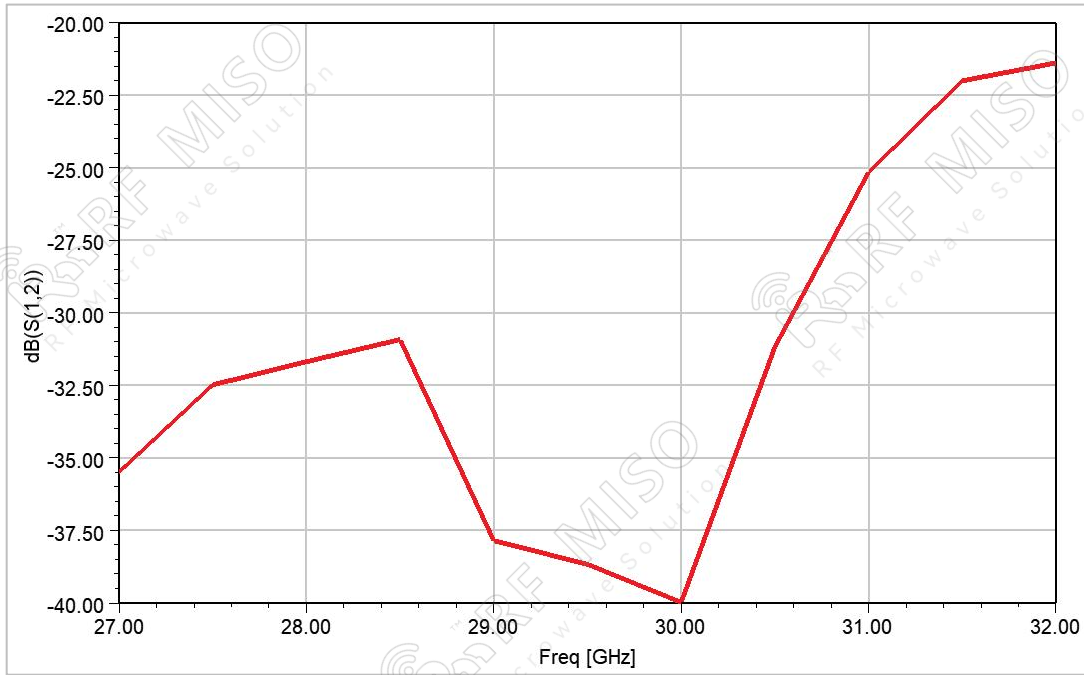

Cross Polarization

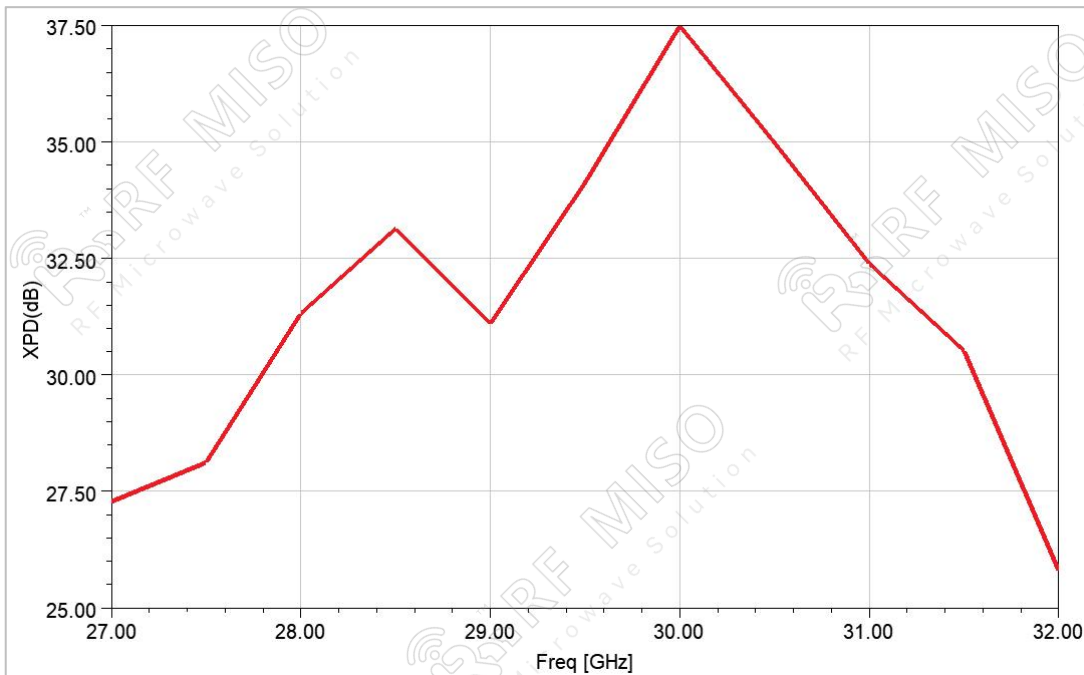

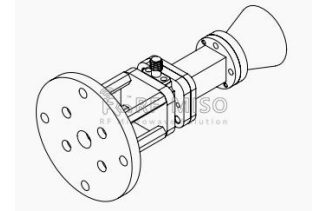

Dual Circular Polarization Horn Antenna  
15 dBi Typ. Gain, 27-32 GHz Frequency Range

**Dual Circular Polarized Horn Antenna Data Sheet**

**RM-DCPHA2732-15**

F/B

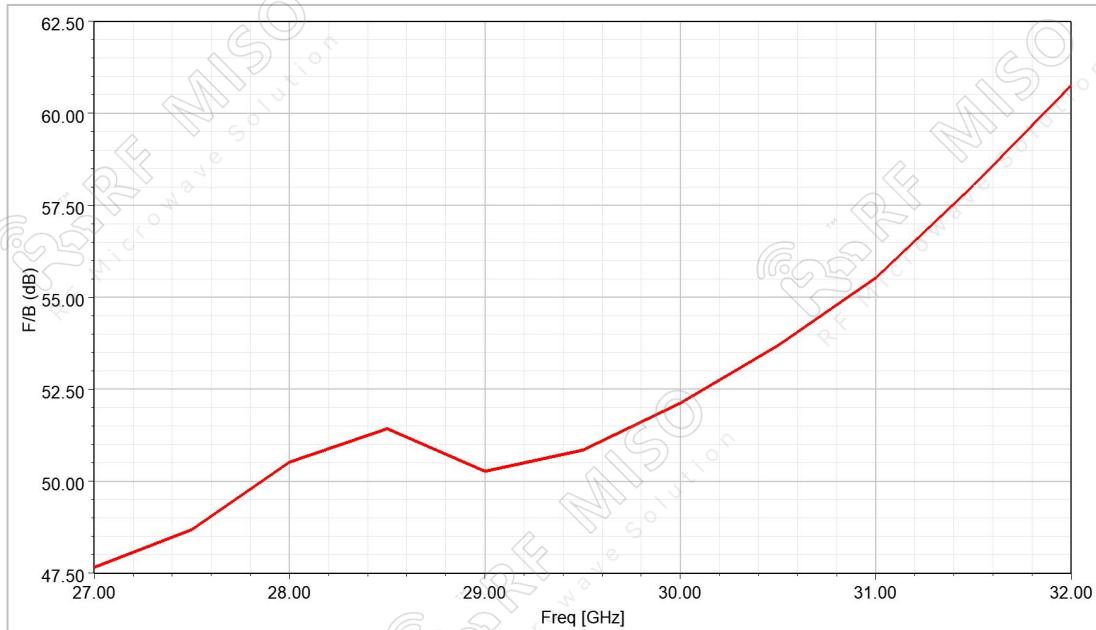

**Gain Patterns**

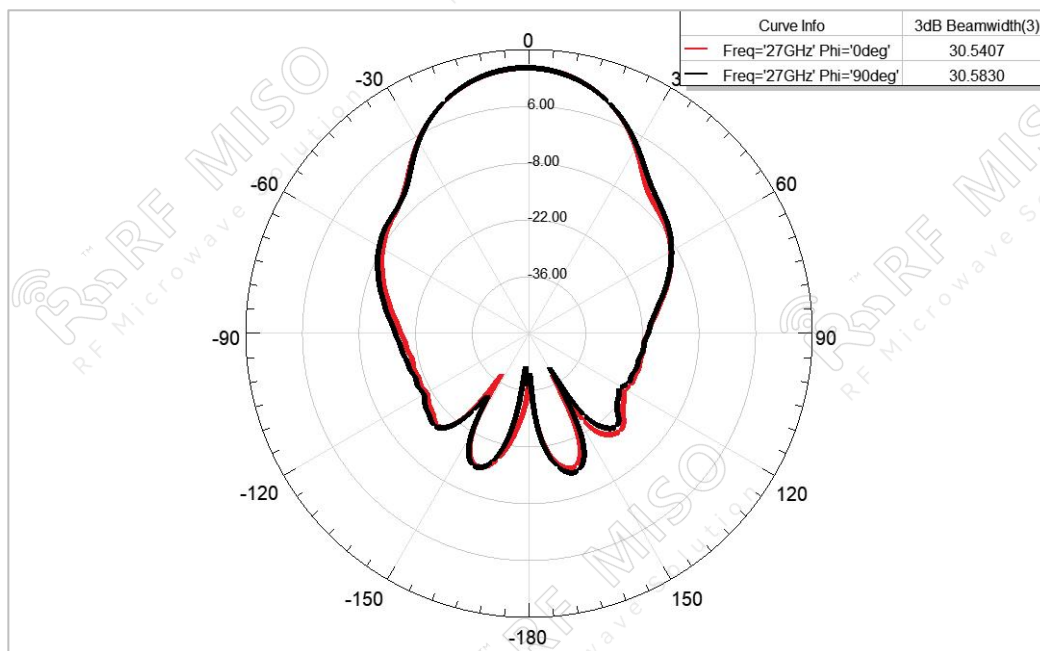

27GHz

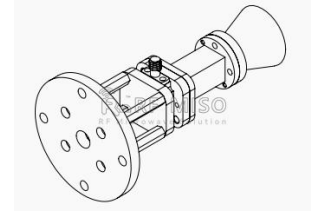

Dual Circular Polarization Horn Antenna  
15 dBi Typ. Gain, 27-32 GHz Frequency Range

## Dual Circular Polarized Horn Antenna Data Sheet

**RM-DCPHA2732-15**

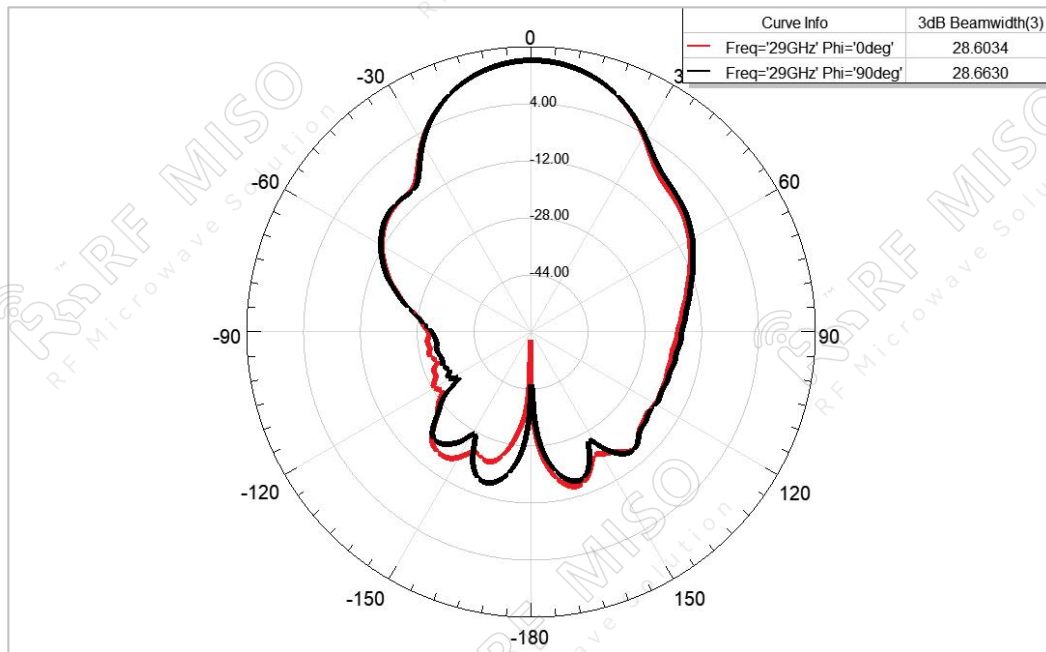

29GHz

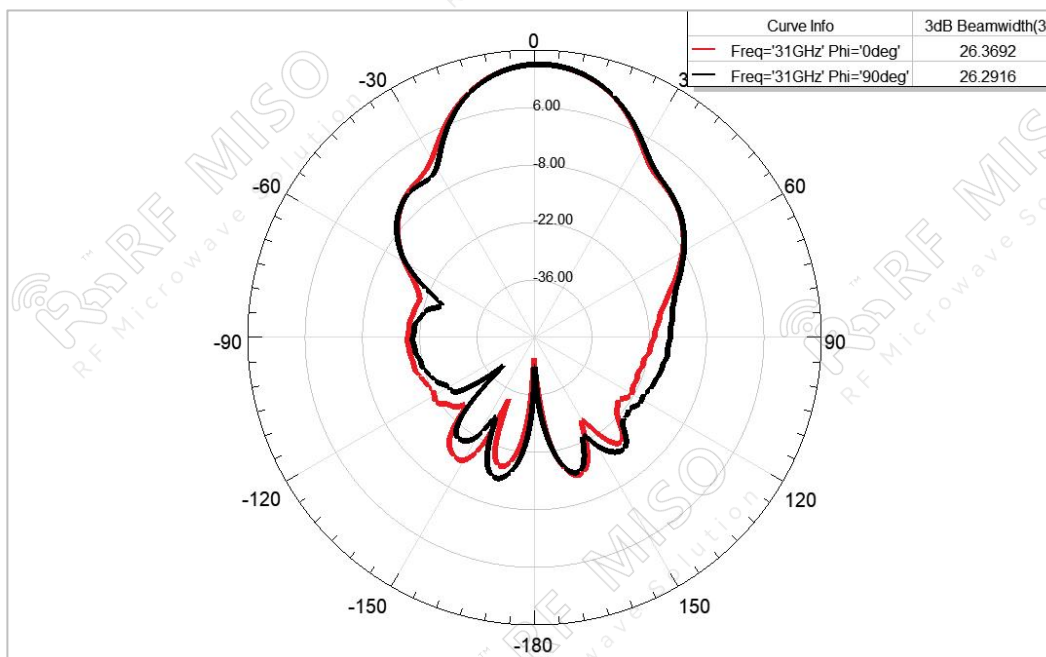

31GHz