

*Dual Circular Polarization Horn Antenna
10 dBi Typ. Gain, 1-2 GHz Frequency Range*

Dual Circular Polarized Horn Antenna Data Sheet

RM-DCPHA12-10

Descriptions

RF MISO's **Model RM-DCPHA12-10** is a dual circular polarized horn antenna that operates from 1 to 2 GHz, The antenna offers 10dBi typical gain. The antenna VSWR is typical 1.3:1. the interface is SMA-F. The antenna can be widely used in EMI detection, orientation, reconnaissance, antenna gain and pattern measurement and other application fields.

Specifcaions

RM-DCPHA12-10		
Parameters	Typical	Units
Frequency Range	1-2	GHz
Gain	10 Typ.	dBi
VSWR	1.3 Typ.	
Polarization	Dual Circular	
Cross Polarization	40 Typ.	dB
F/B	50 Typ.	dB
Coaxial Interface	SMA-Female	
Material	Al	
Finishing	Paint Black	
Size(L*W*H)	334.0*214.1*224.4(±5)	mm
Weight	3.163	Kg

Dual Circular Polarization Horn Antenna
10 dBi Typ. Gain, 1-2 GHz Frequency Range

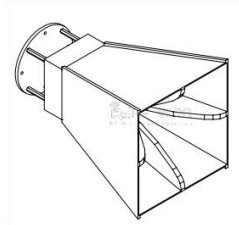

Dual Circular Polarized Horn Antenna Data Sheet

RM-DCPHA12-10

Outline Drawing

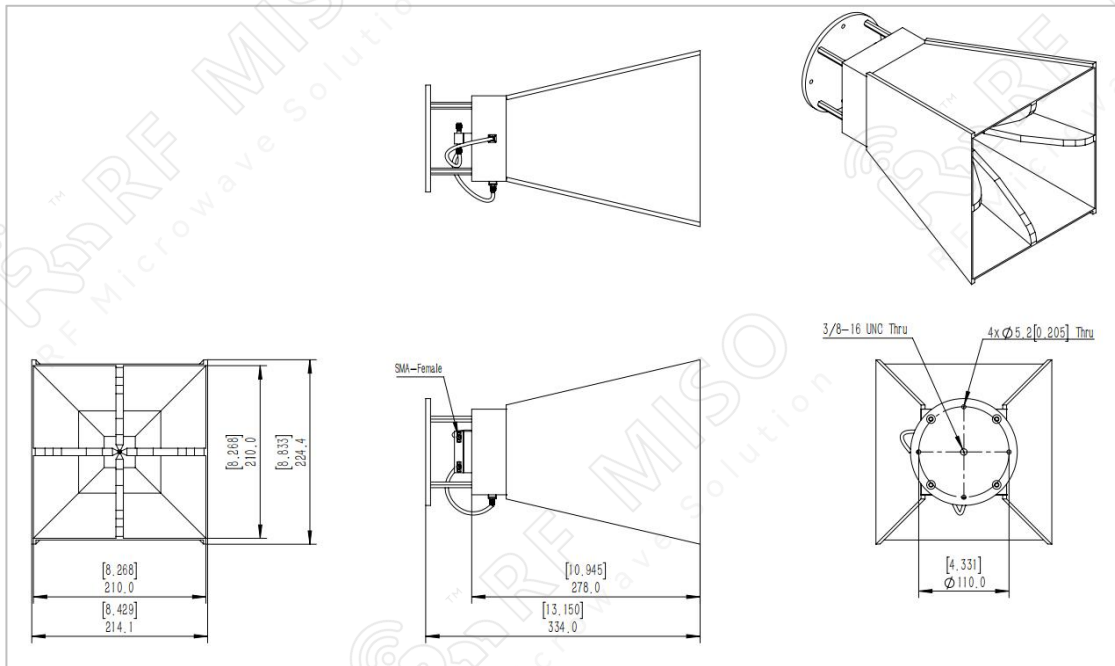

Simulation Data

Gain

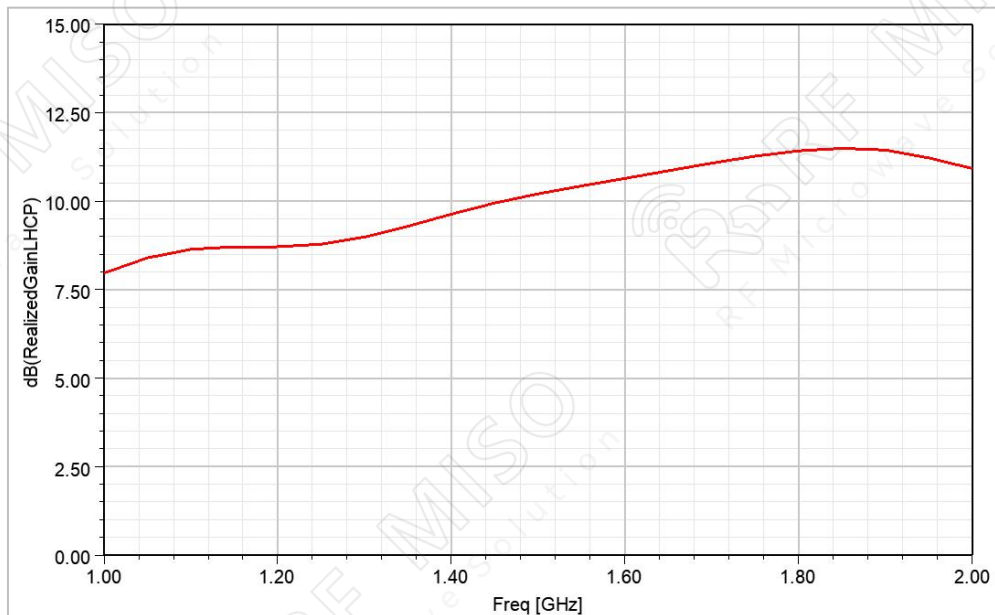

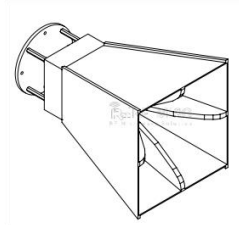

Dual Circular Polarization Horn Antenna
10 dBi Typ. Gain, 1-2 GHz Frequency Range

Dual Circular Polarized Horn Antenna Data Sheet

RM-DCPHA12-10

VSWR

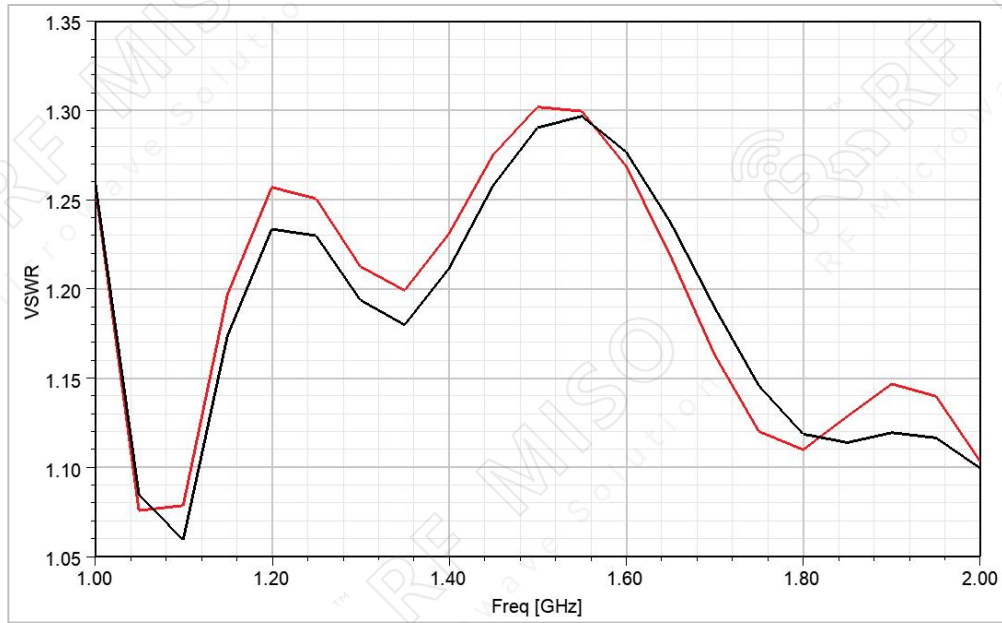

Cross Polarization

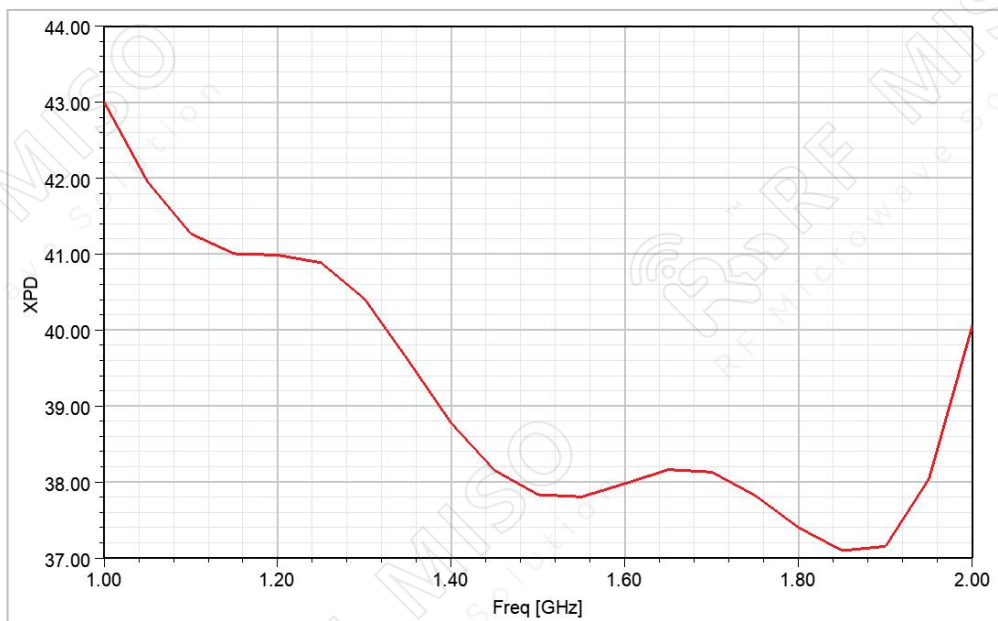

Dual Circular Polarization Horn Antenna
10 dBi Typ. Gain, 1-2 GHz Frequency Range

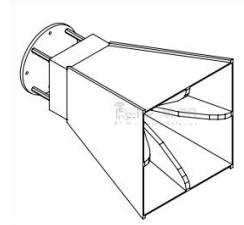

Dual Circular Polarized Horn Antenna Data Sheet

RM-DCPHA12-10

F/B

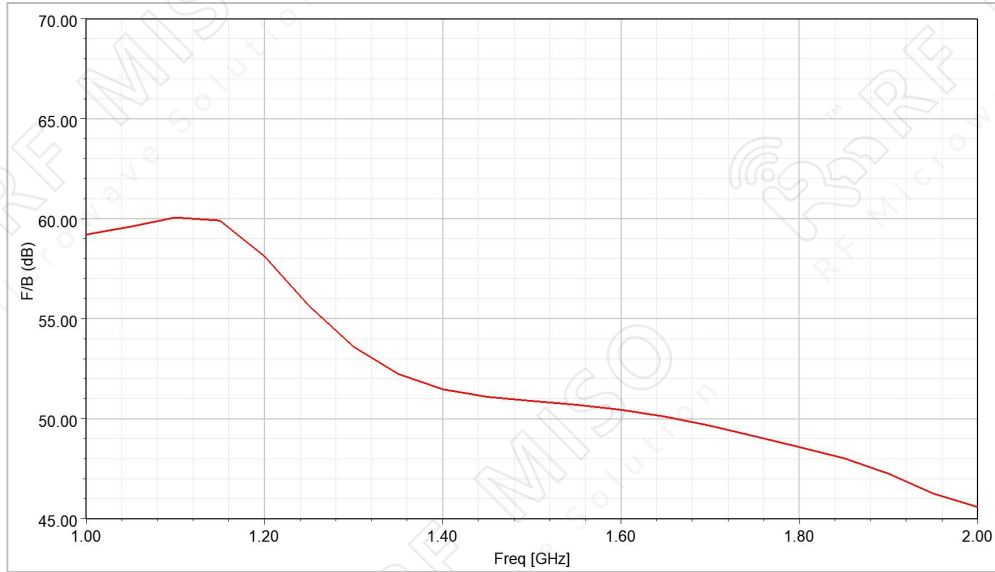

Gain Patterns

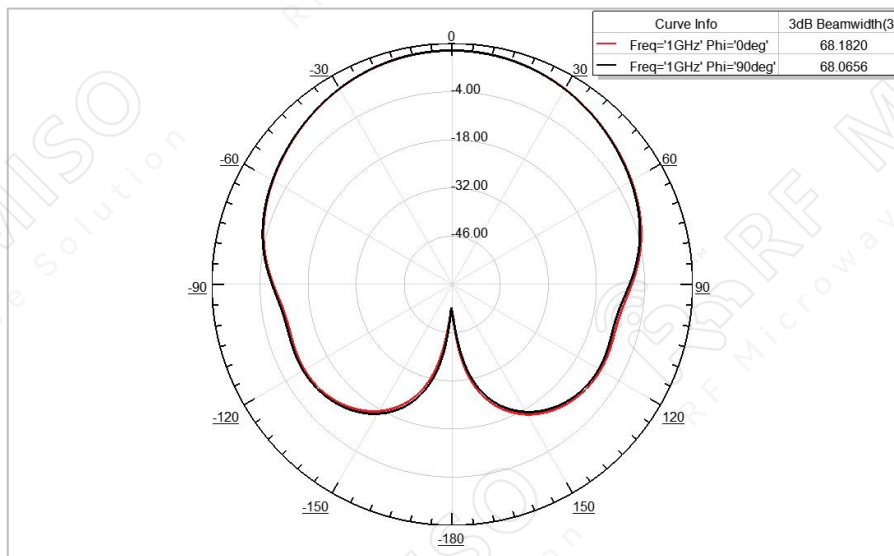

1 GHz

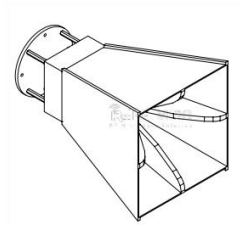

Dual Circular Polarization Horn Antenna
10 dBi Typ. Gain, 1-2 GHz Frequency Range

Dual Circular Polarized Horn Antenna Data Sheet

RM-DCPHA12-10

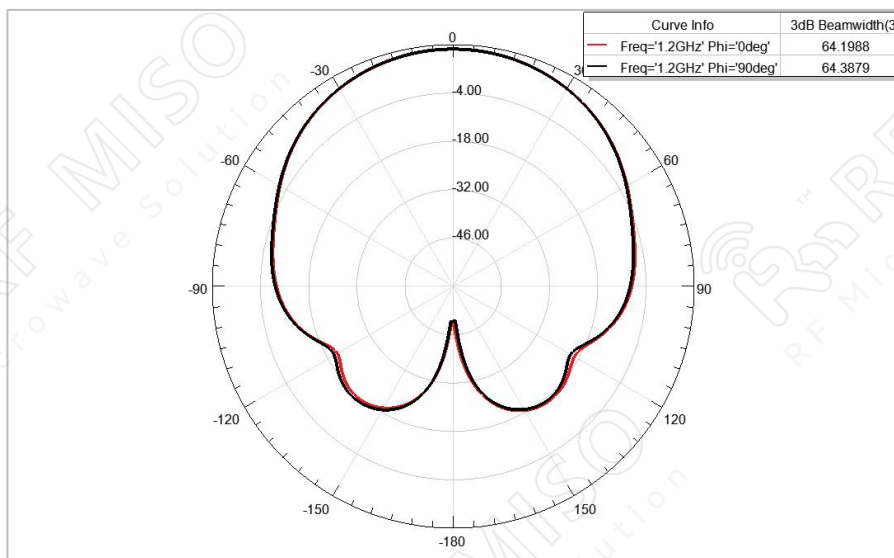

1.2 GHz

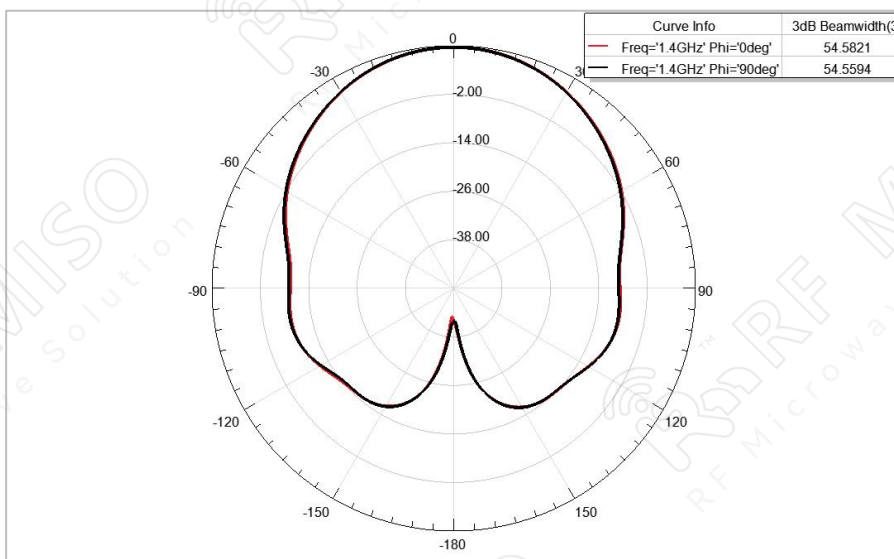

1.4 GHz

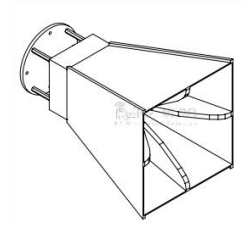

Dual Circular Polarization Horn Antenna
10 dBi Typ. Gain, 1-2 GHz Frequency Range

Dual Circular Polarized Horn Antenna Data Sheet

RM-DCPHA12-10

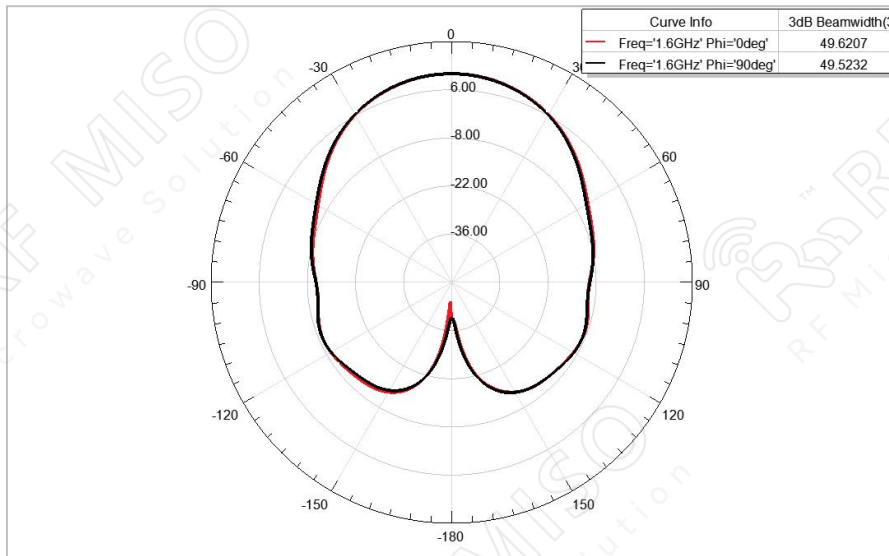

1.6 GHz

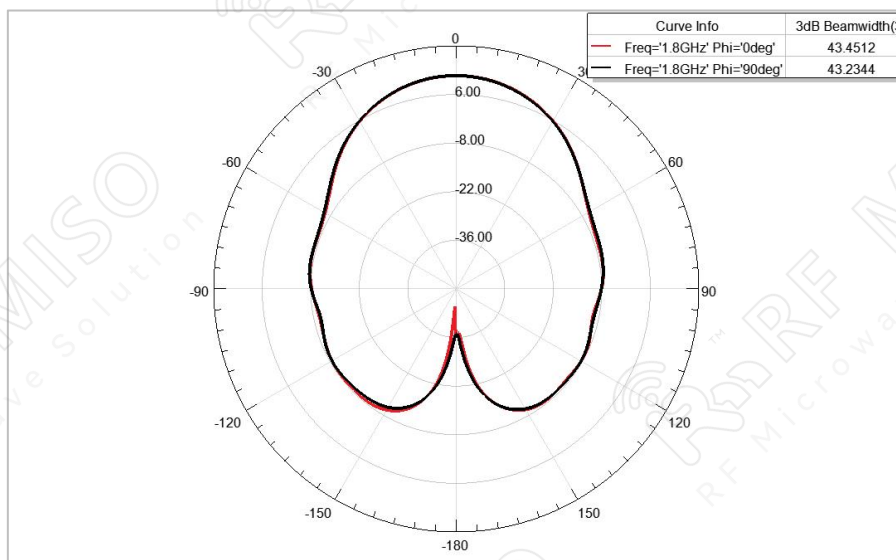

1.8 GHz

Dual Circular Polarization Horn Antenna
10 dBi Typ. Gain, 1-2 GHz Frequency Range

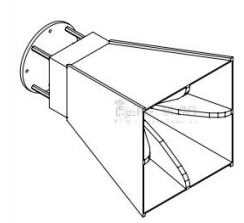

Dual Circular Polarized Horn Antenna Data Sheet

RM-DCPHA12-10

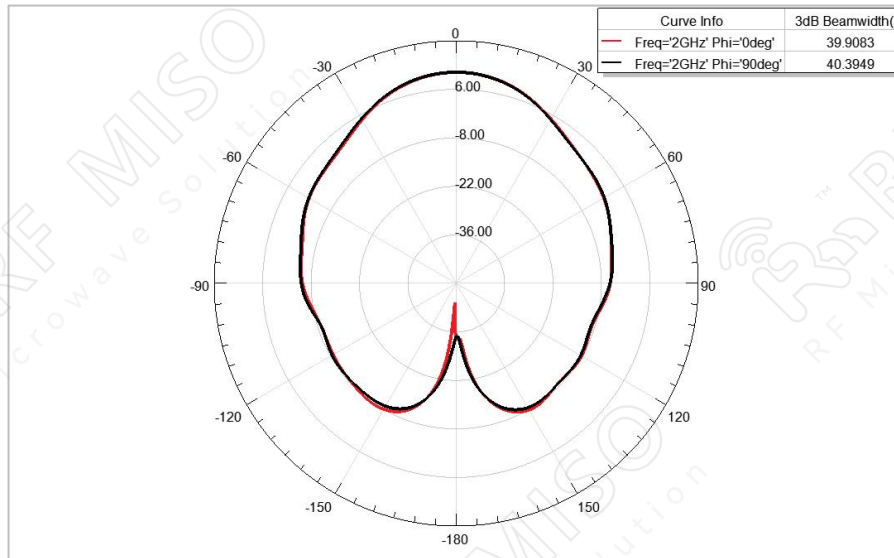

2 GHz