

*Conical Dual Polarized Horn Antenna
15dBi Typ.Gain, 2-18 GHz Frequency Range*

Conical Dual Polarized Horn Antenna Data Sheet

RM-CDPHA218-15S

Features

- Broadband Operation
- Dual Polarization
- Moderate Gain
- Communication Systems
- Radar Systems
- System Setups

Description

The **RM-CDPHA218-15S** is a full-band, dual-polarized horn antenna assembly that operates in the frequency range of 2 to 18 GHz. The antenna offers a typical gain of 15 dBi and low VSWR 1.5:1. The antenna can be widely used in EMI detection, orientation, reconnaissance, antenna gain and pattern measurement and other application fields.

Specifications

RM-CDPHA218-15S		
Item	Specification	Units
Frequency Range	2-18	GHz
Gain	15 Typ.	dBi
VSWR	1.5:1 Typ.	
XPD	50	dB
Polarization	Dual Linear	
Connector	SMA-Female	
Size(L*W*H)	201.0*Ø107.8(±5)	mm
Weight	0.369	Kg
Material and Finish	Al	

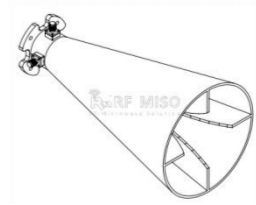

Conical Dual Polarized Horn Antenna
15dBi Typ. Gain, 2-18 GHz Frequency Range

Conical Dual Polarized Horn Antenna Data Sheet

RM-CDPHA218-15S

Outline Drawing

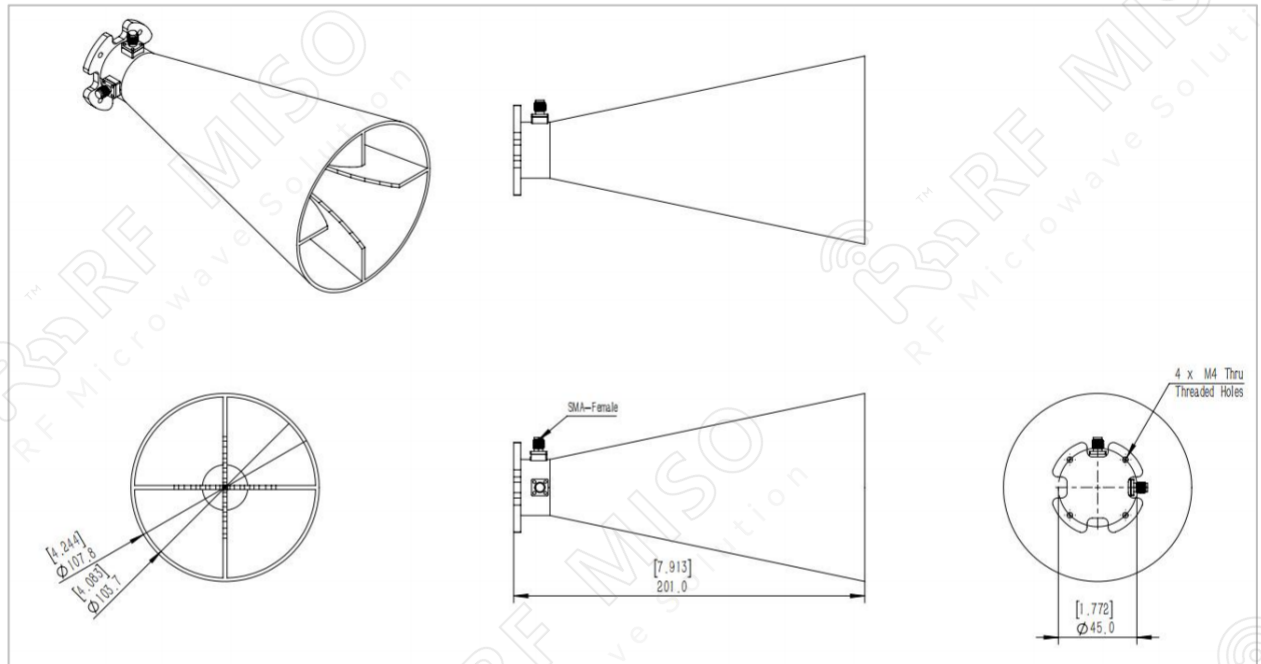

Simulated Data

VSWR

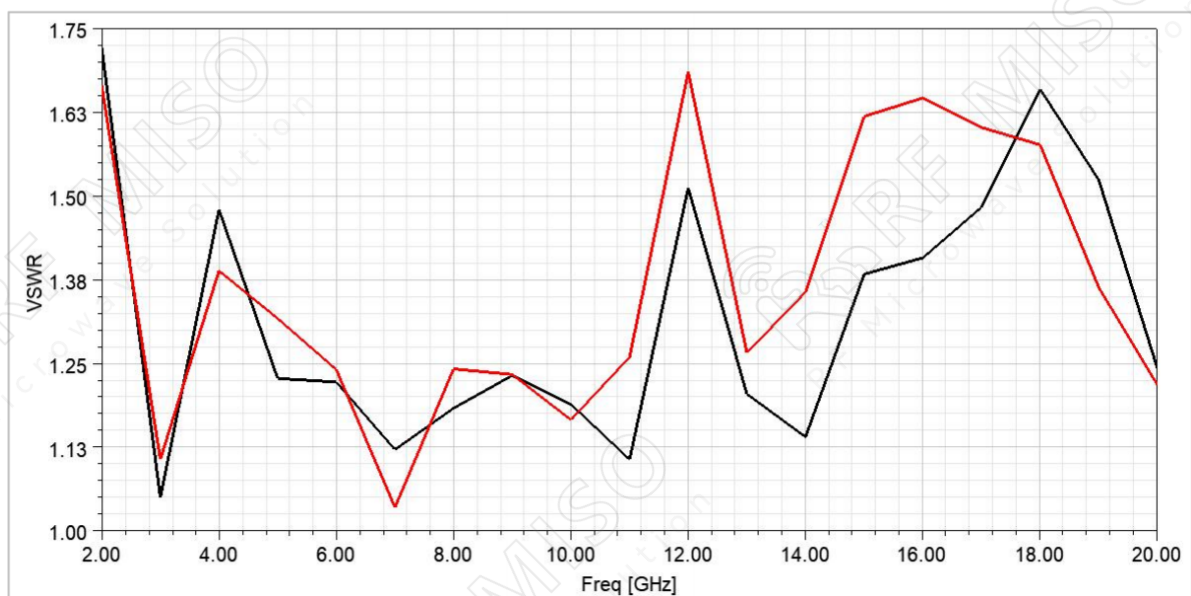

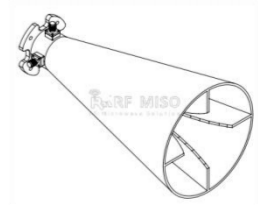

Conical Dual Polarized Horn Antenna
15dBi Typ. Gain, 2-18 GHz Frequency Range

Conical Dual Polarized Horn Antenna Data Sheet

RM-CDPHA218-15S

Gain

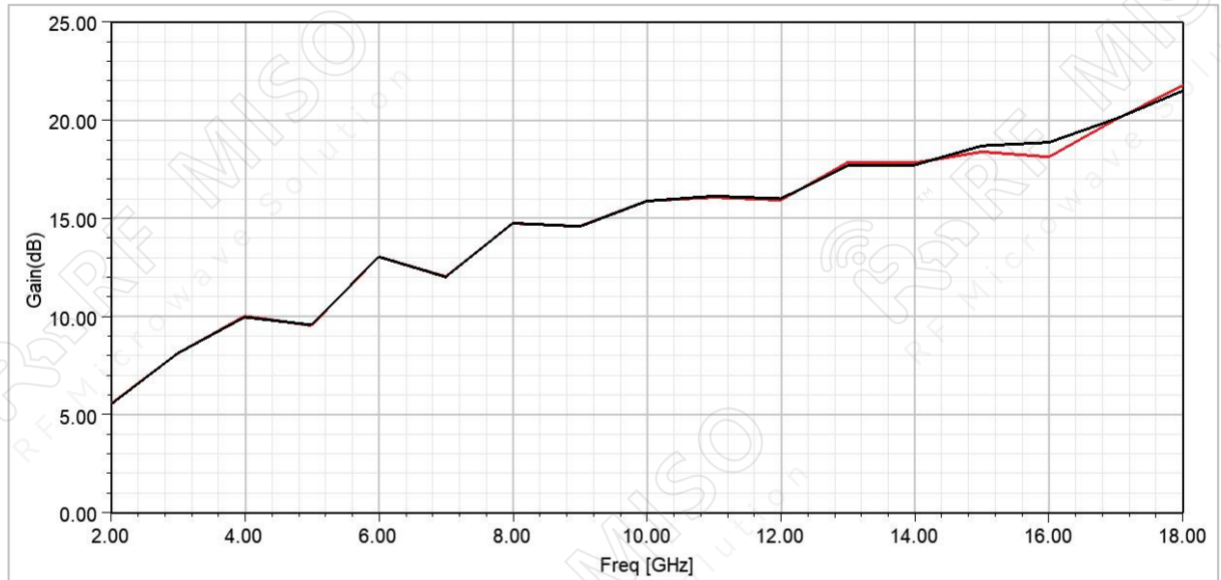

XPD

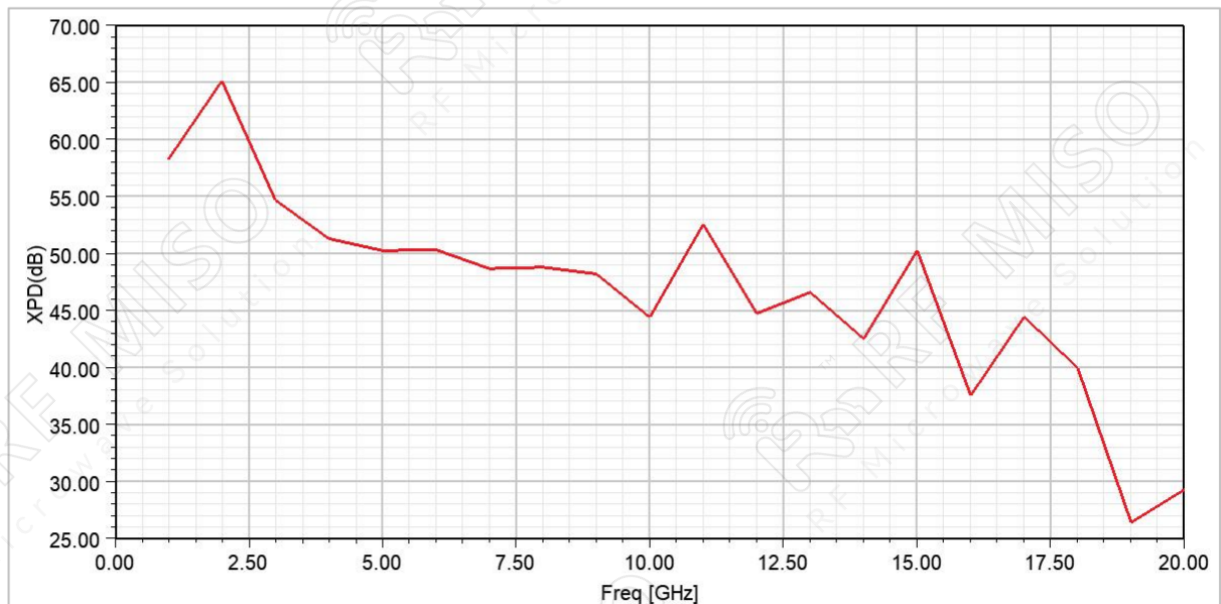

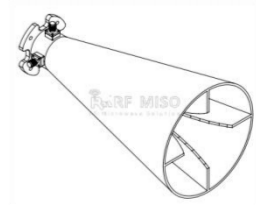

Conical Dual Polarized Horn Antenna
15dBi Typ. Gain, 2-18 GHz Frequency Range

Conical Dual Polarized Horn Antenna Data Sheet

RM-CDPHA218-15S

Gain Pattern

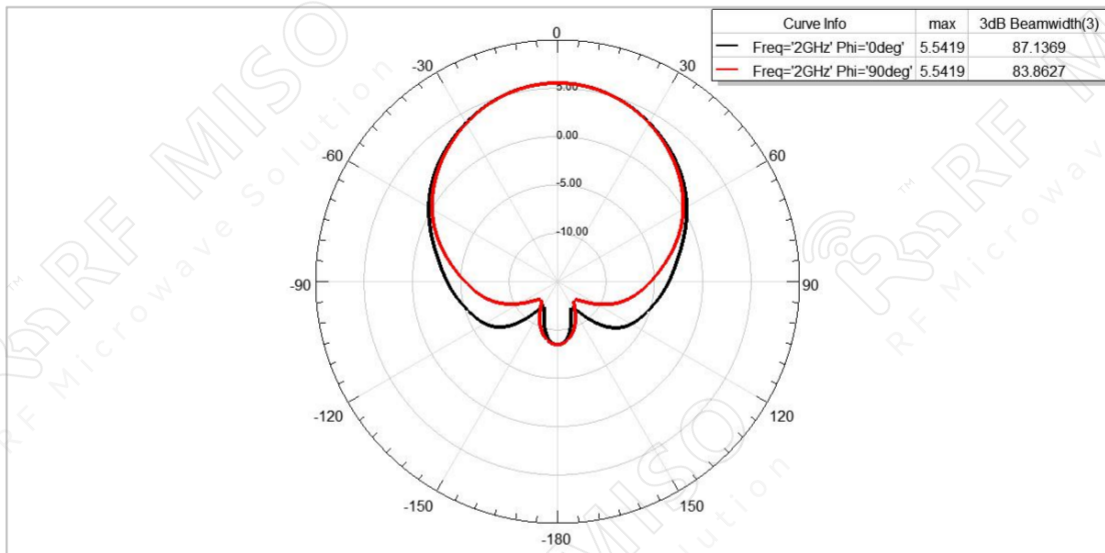

2 GHz

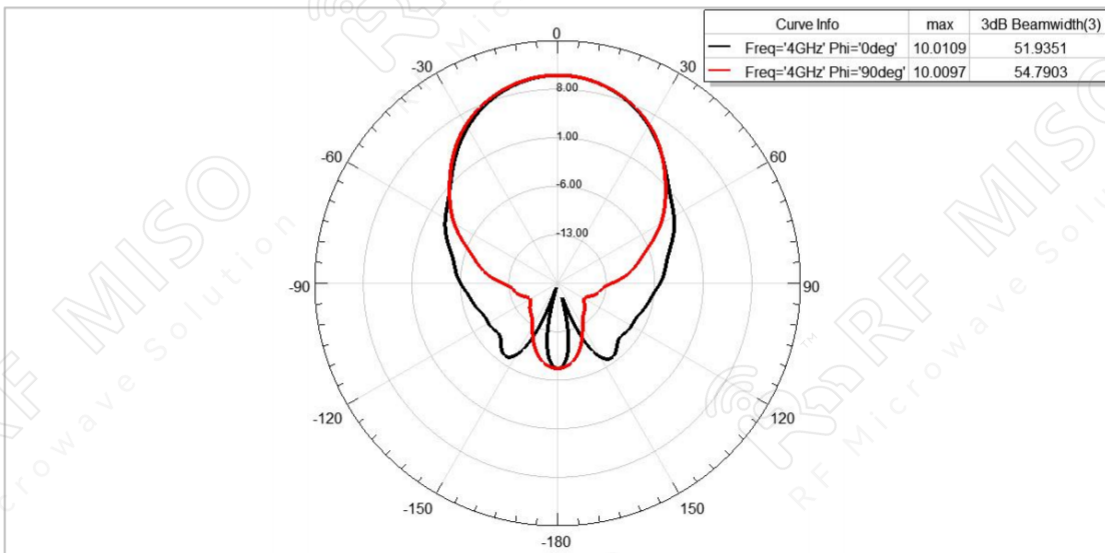

4 GHz

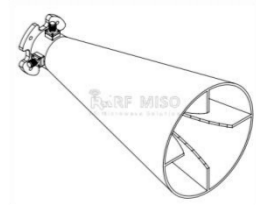

Conical Dual Polarized Horn Antenna
15dBi Typ.Gain, 2-18 GHz Frequency Range

Conical Dual Polarized Horn Antenna Data Sheet

RM-CDPHA218-15S

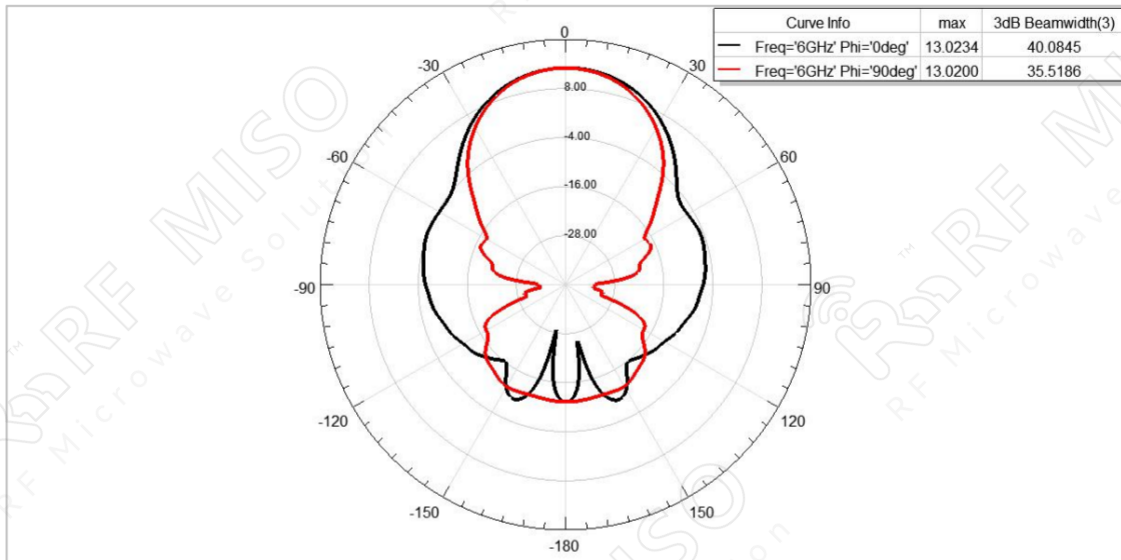

6 GHz

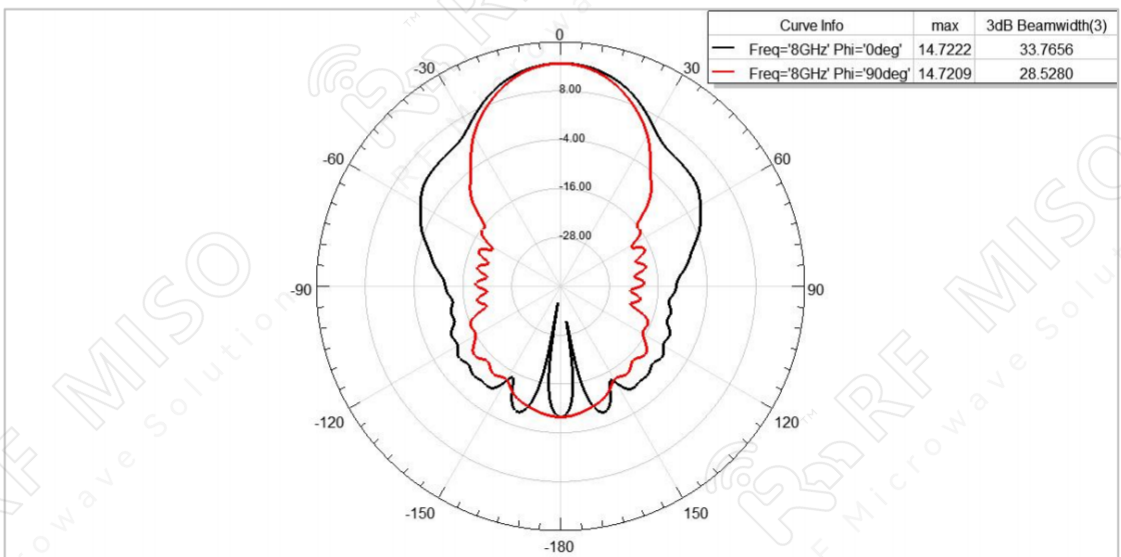

8 GHz

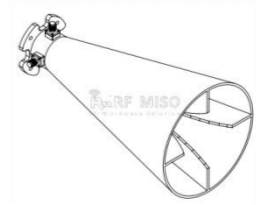

Conical Dual Polarized Horn Antenna
15dBi Typ.Gain, 2-18 GHz Frequency Range

Conical Dual Polarized Horn Antenna Data Sheet

RM-CDPHA218-15S

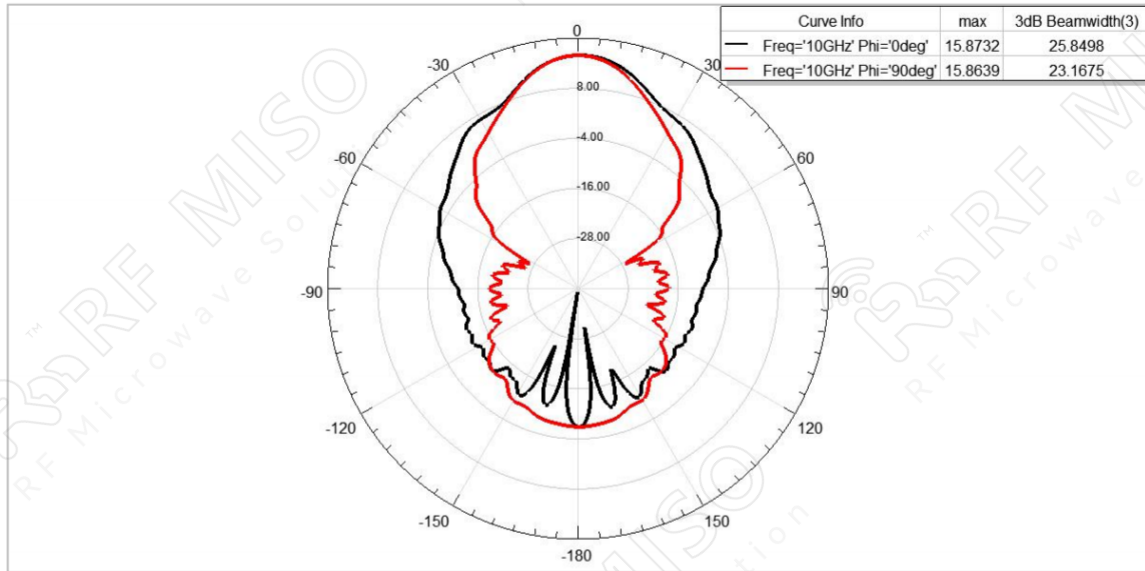

10 GHz

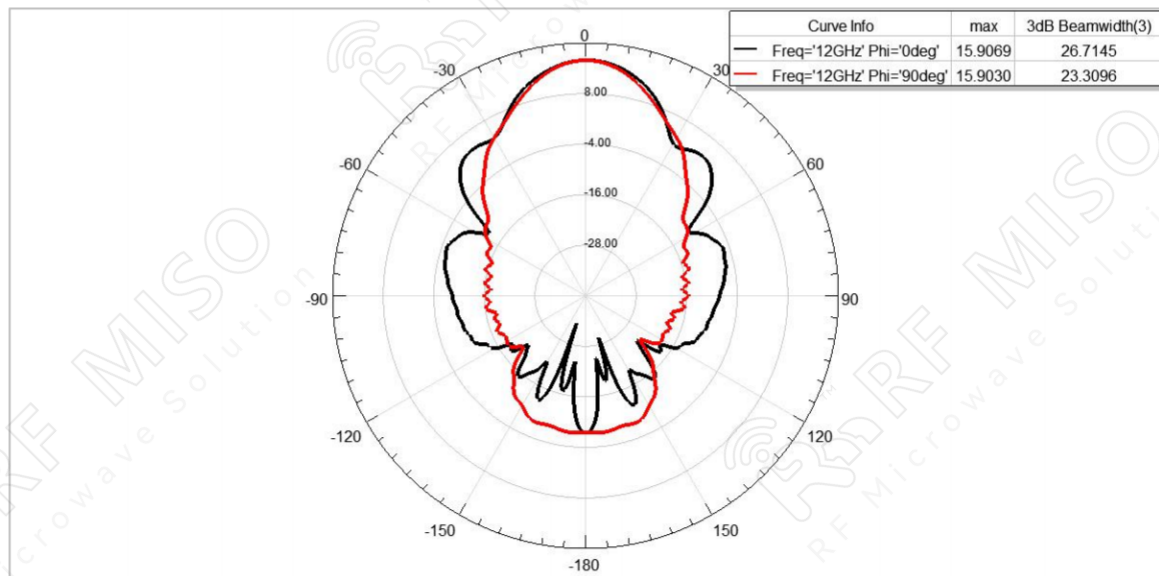

12 GHz

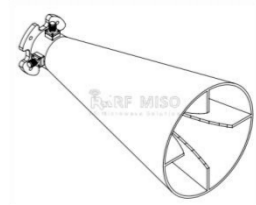

Conical Dual Polarized Horn Antenna
15dBi Typ.Gain, 2-18 GHz Frequency Range

Conical Dual Polarized Horn Antenna Data Sheet

RM-CDPHA218-15S

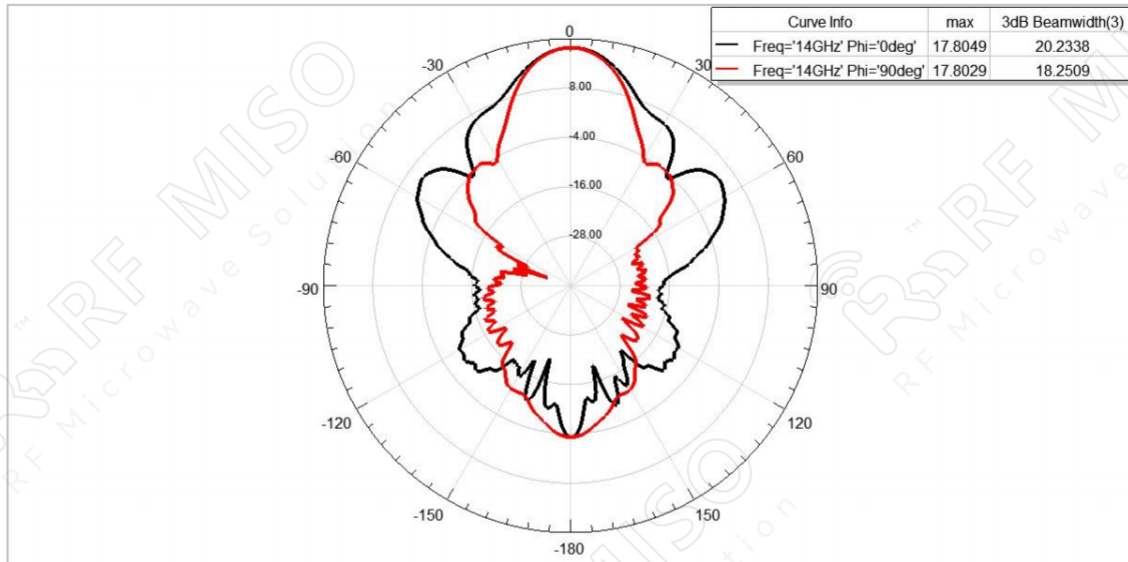

14 GHz

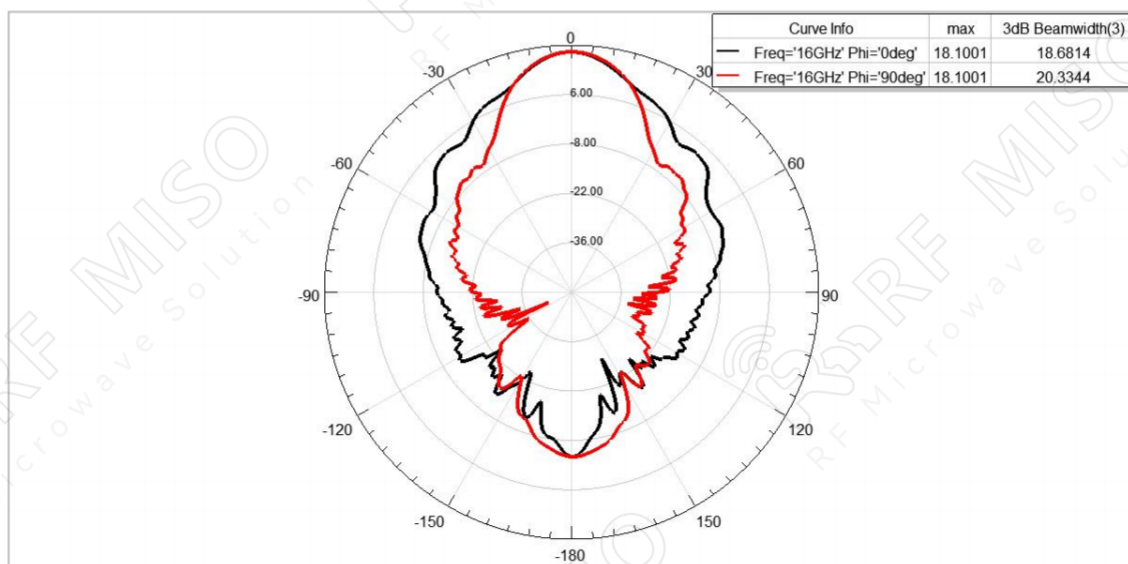

16 GHz

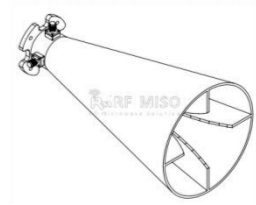

Conical Dual Polarized Horn Antenna
15dBi Typ.Gain, 2-18 GHz Frequency Range

Conical Dual Polarized Horn Antenna Data Sheet

RM-CDPHA218-15S

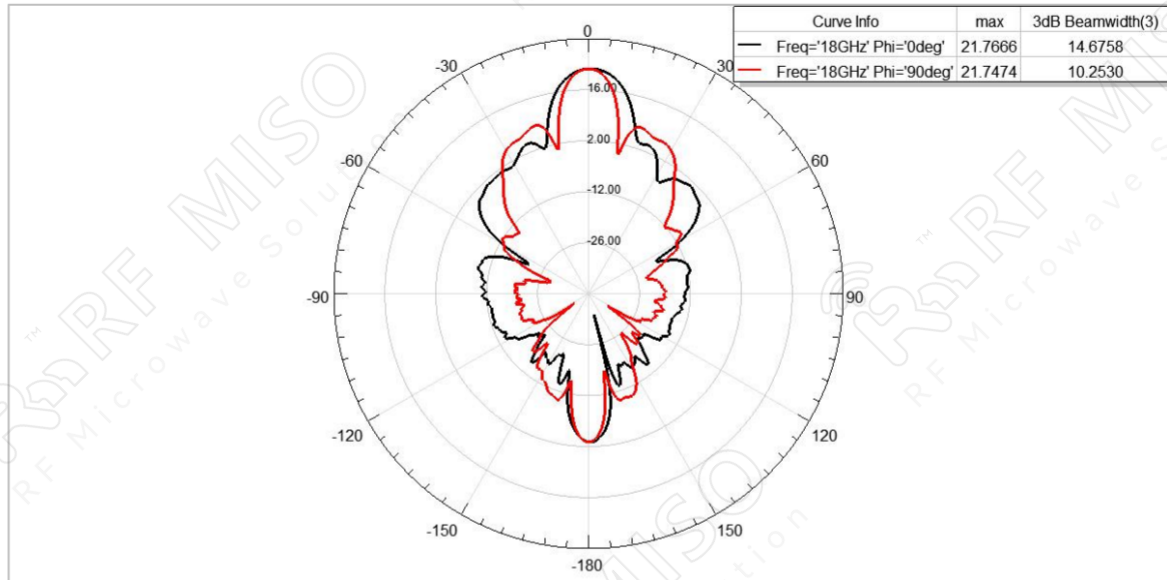

18 GHz