

*Biconical Antenna 1-20 GHz Frequency Range
2 dBi Typ. Gain, Slant polarization*



Biconical Antenna Data Sheet

RM-BCA120-2

Descriptions

RF MISO's **Model RM-BCA120-2** is a slant polarization biconical antenna that operates from 1-20GHz. The antenna offers a gain 2 dBi Typ. and low VSWR 1.5:1 with 2.92-Female connector. The use of foam covers between the outer polarization layers can effectively reduce the wind resistance on the antenna surface, especially in outdoor applications, and improve the mechanical stability of the antenna.

Specifications

RM-BCA120-2		
Parameters	Typical	Units
Frequency Range	1-20	GHz
Gain	2 Typ.	dBi
VSWR	1.5 Typ.	
Polarization	45° slant	
Connector	2.92-Female	
Body Material	Al	
Size	Φ 199.0*160.5	mm
Weight	3.302	Kg
Power Handling,CW	20	W
Power Handling,Peak	40	W

*Biconical Antenna 1-20 GHz Frequency Range
2 dBi Typ. Gain, Slant polarization*



Biconical Antenna Data Sheet

RM-BCA120-2

Outline Drawing

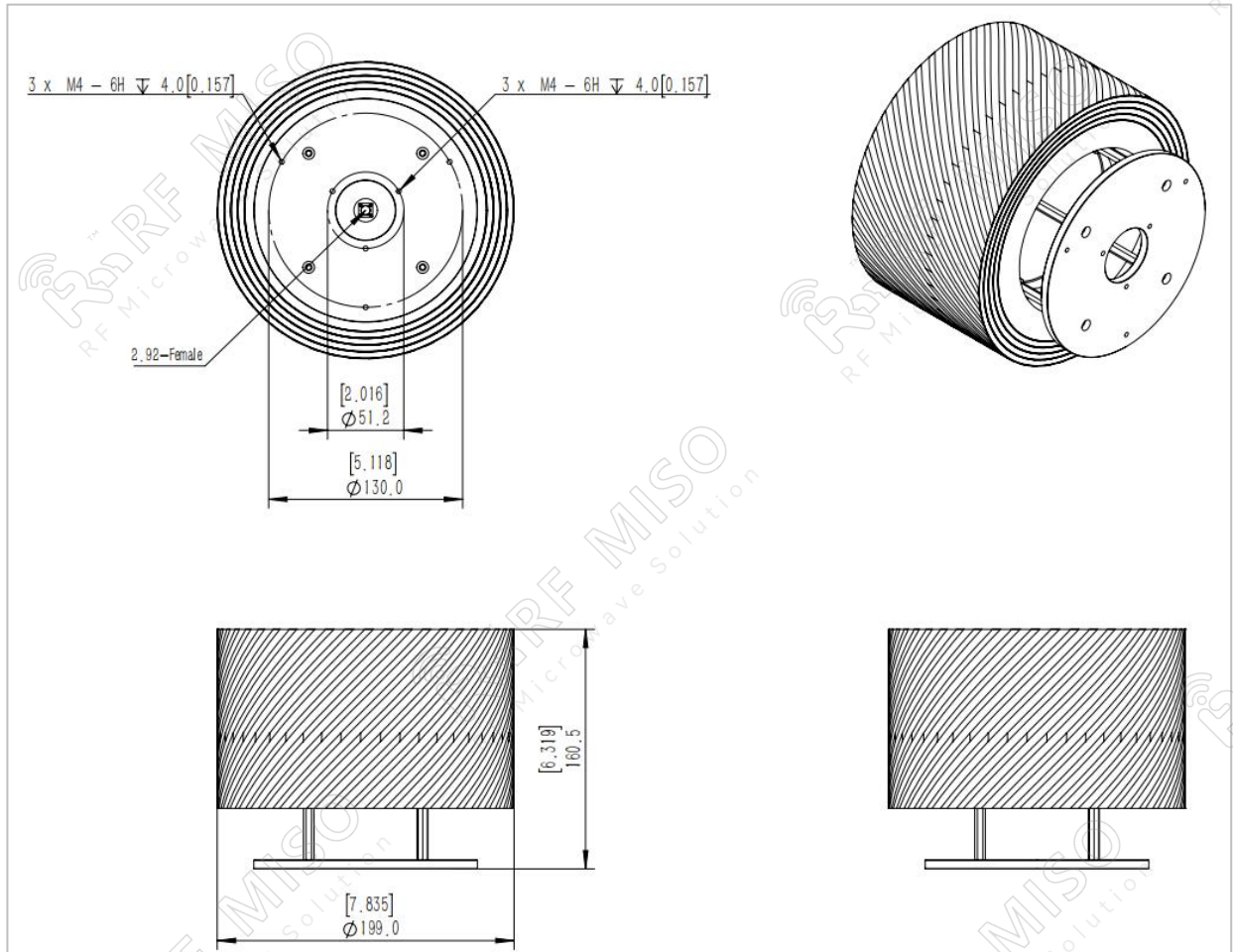



Biconical Antenna 1-20 GHz Frequency Range
2 dBi Typ. Gain, Slant polarization

Biconical Antenna Data Sheet

RM-BCA120-2

Test Data

VSWR

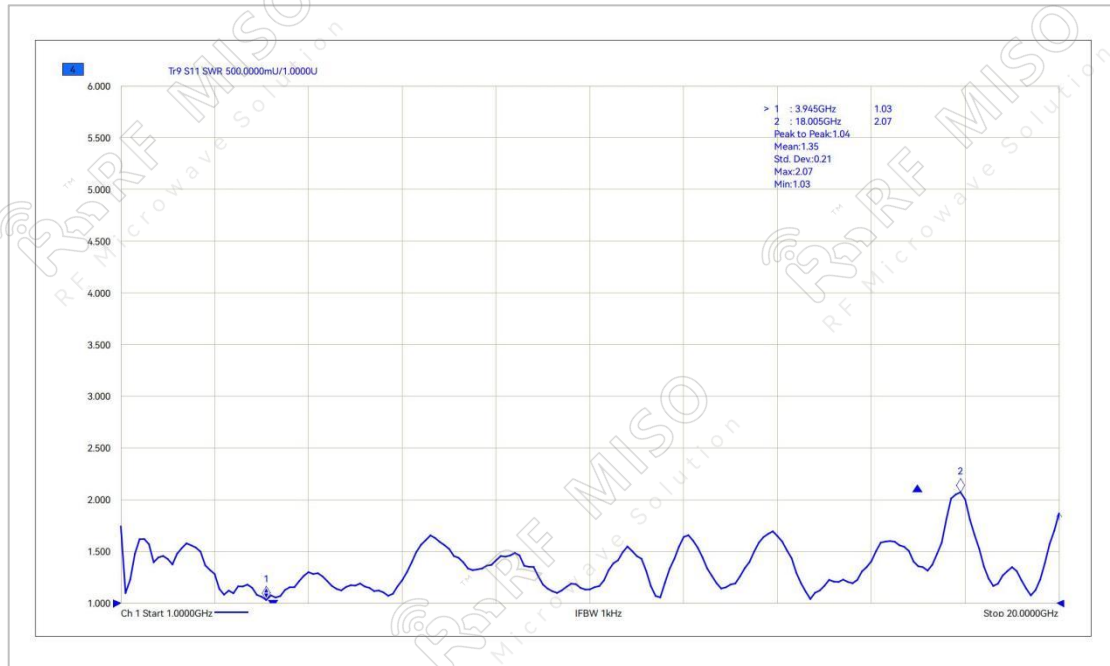

Gain

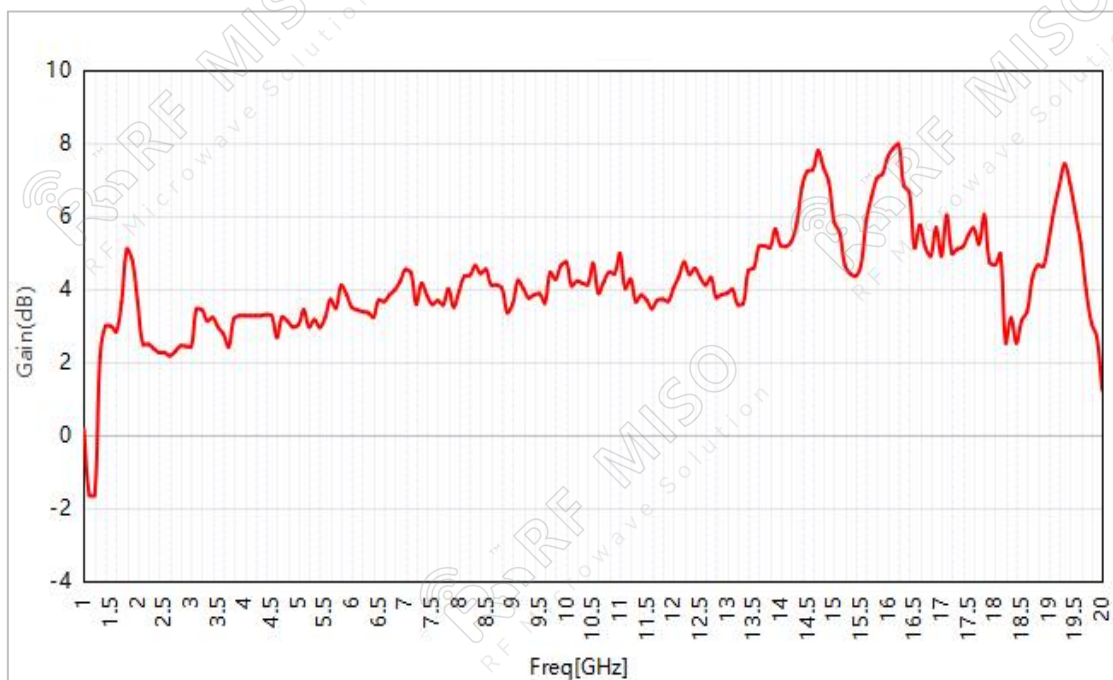



*Biconical Antenna 1-20 GHz Frequency Range
2 dBi Typ. Gain, Slant polarization*

Biconical Antenna Data Sheet

RM-BCA120-2

Radiation Pattern

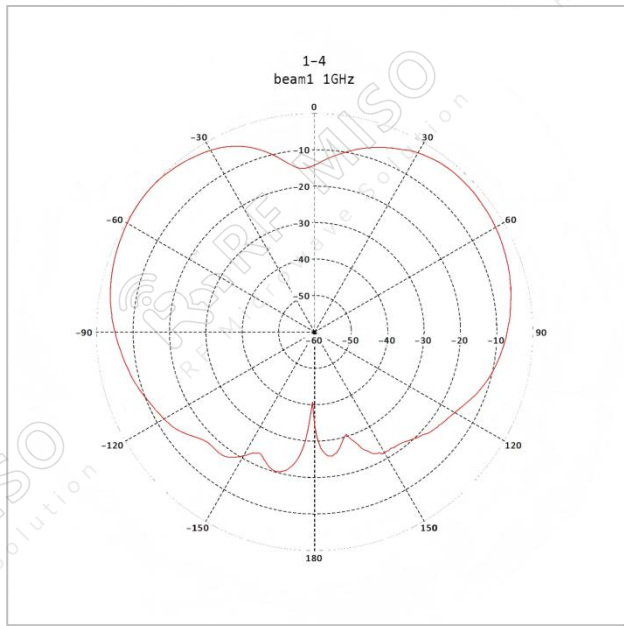

1 GHz

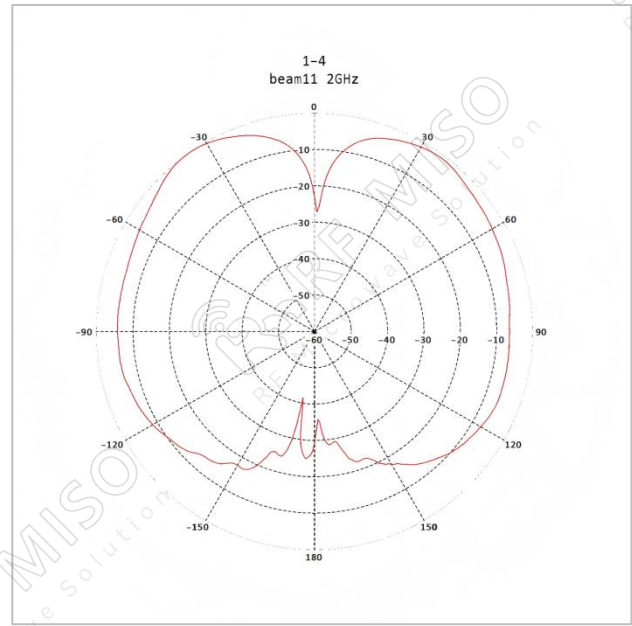

2 GHz

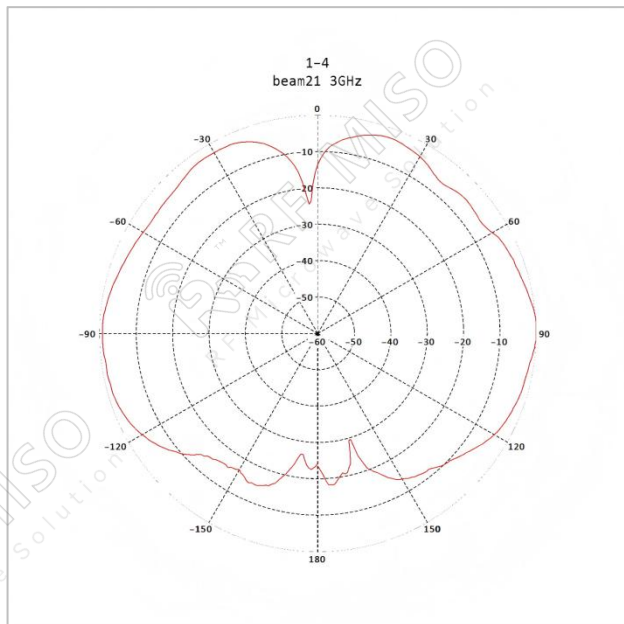

3 GHz

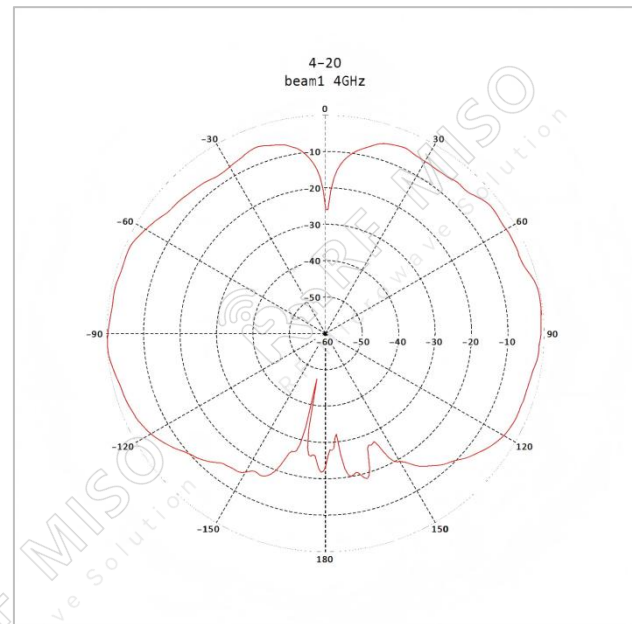

4 GHz



*Biconical Antenna 1-20 GHz Frequency Range
2 dBi Typ. Gain, Slant polarization*

Biconical Antenna Data Sheet

RM-BCA120-2

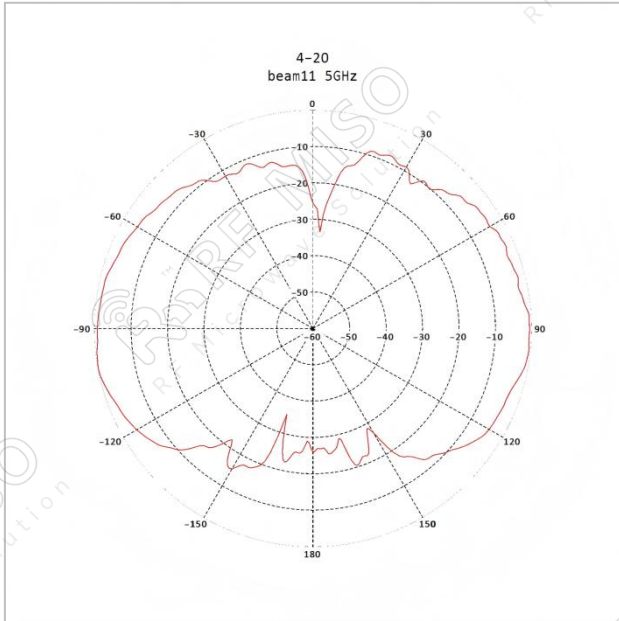

5 GHz

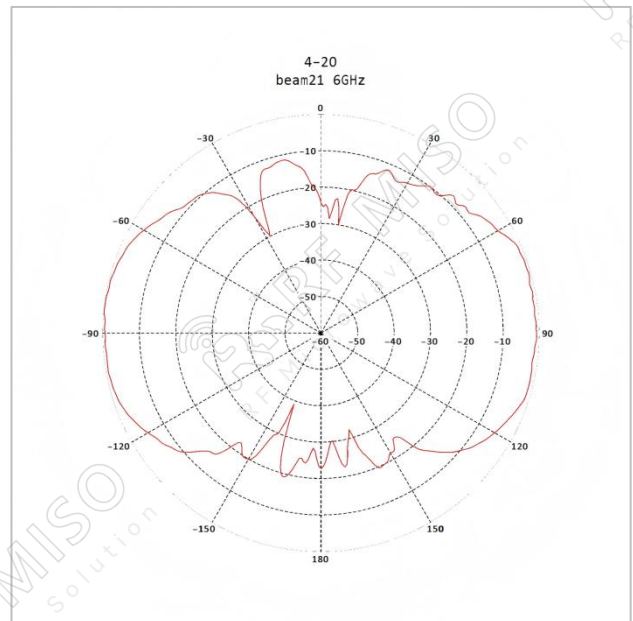

6GHz

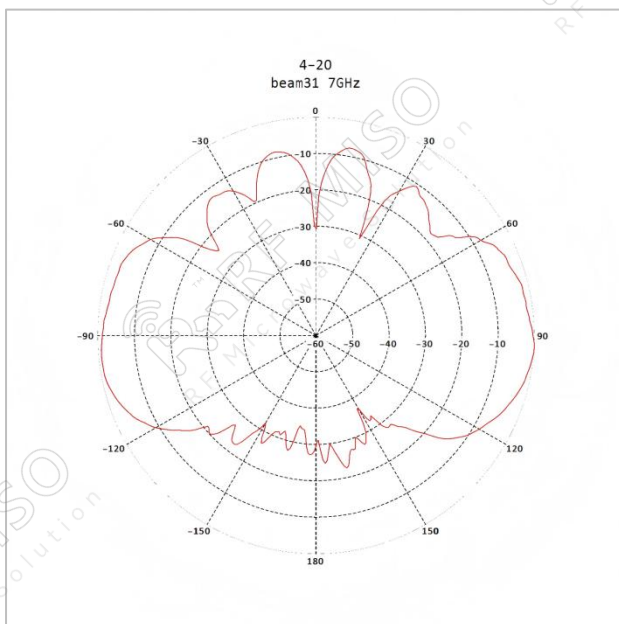

7GHz

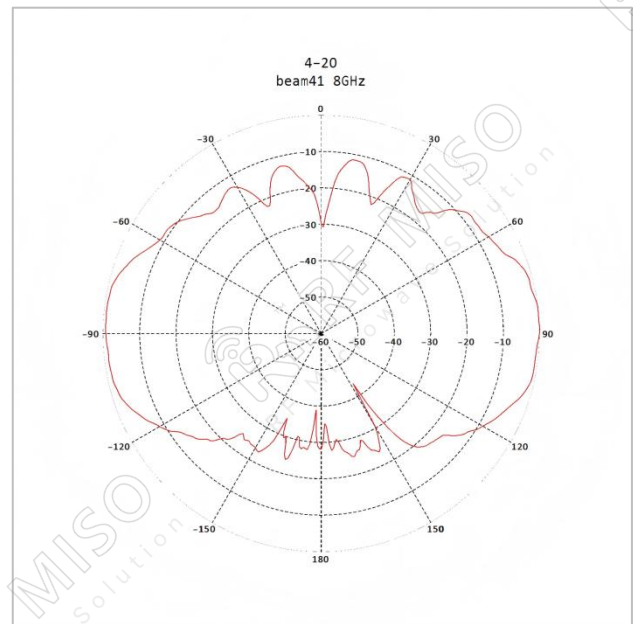

8GHz



*Biconical Antenna 1-20 GHz Frequency Range
2 dBi Typ. Gain, Slant polarization*

Biconical Antenna Data Sheet

RM-BCA120-2

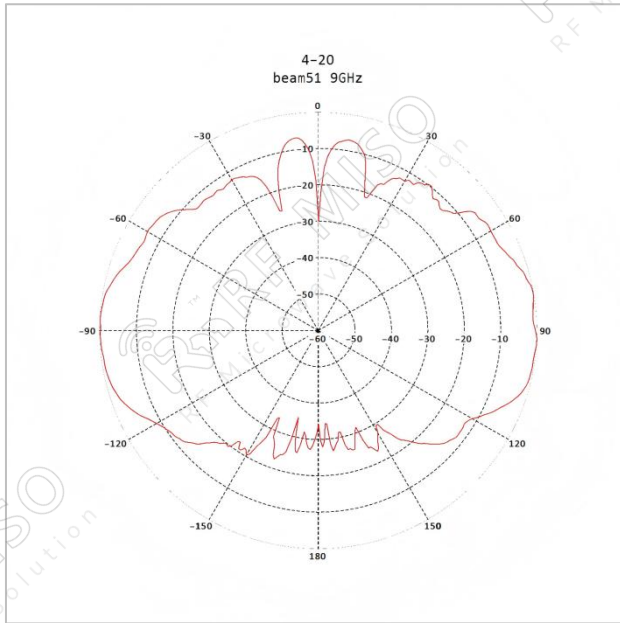

9GHz

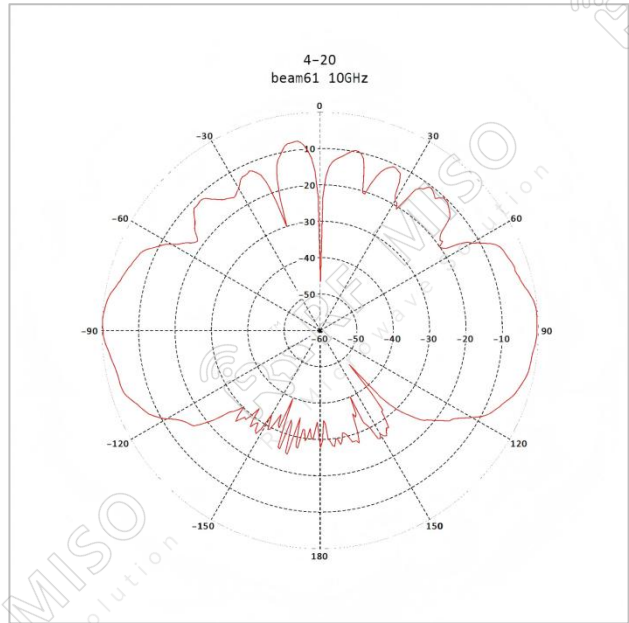

10GHz

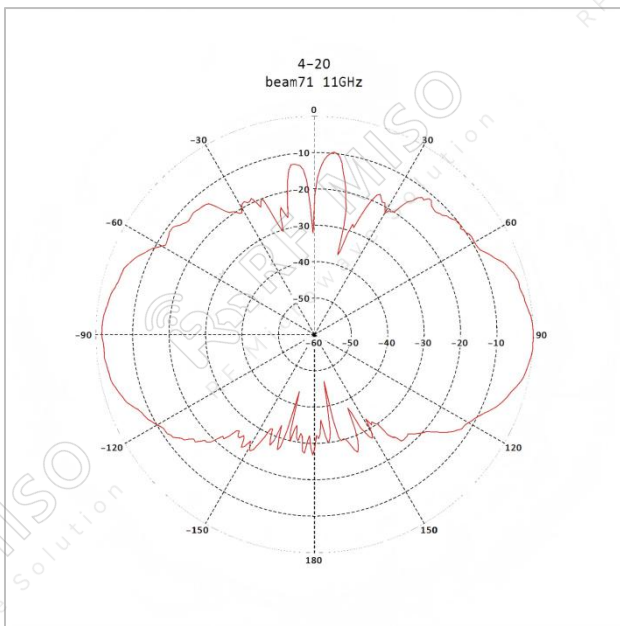

11GHz

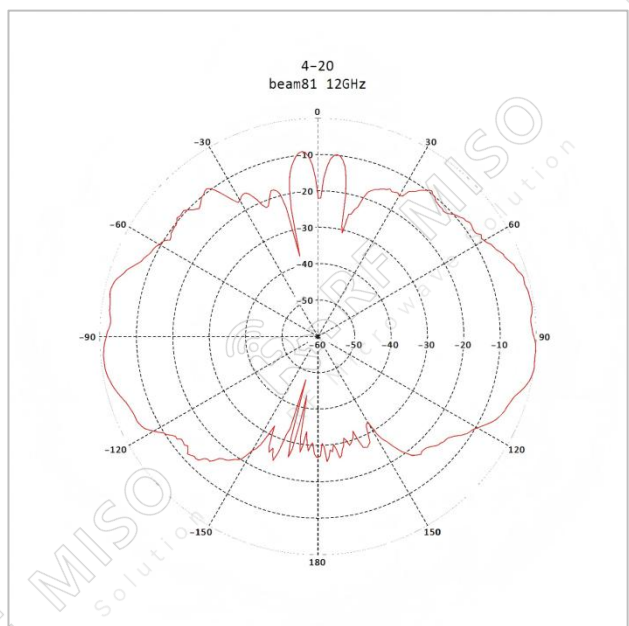

12GHz



Biconical Antenna 1-20 GHz Frequency Range
2 dBi Typ. Gain, Slant polarization

Biconical Antenna Data Sheet

RM-BCA120-2

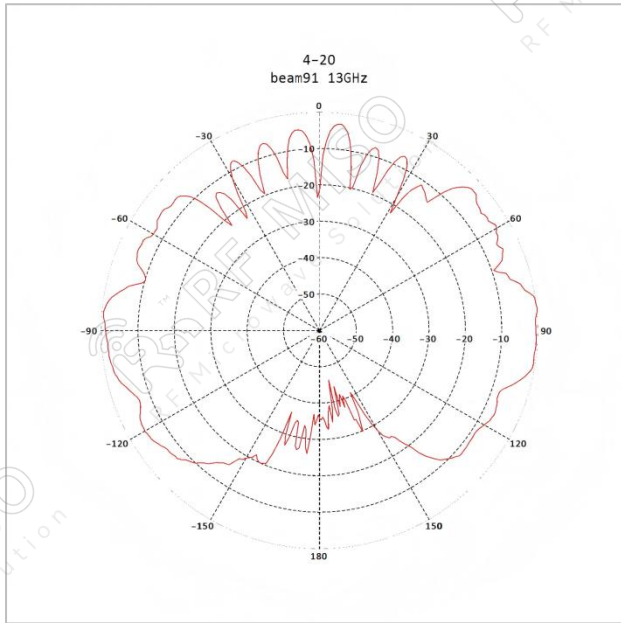

13GHz

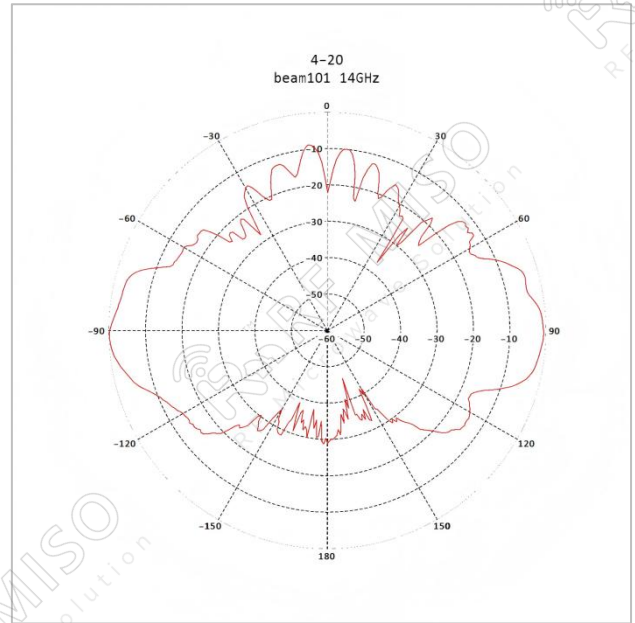

14GHz

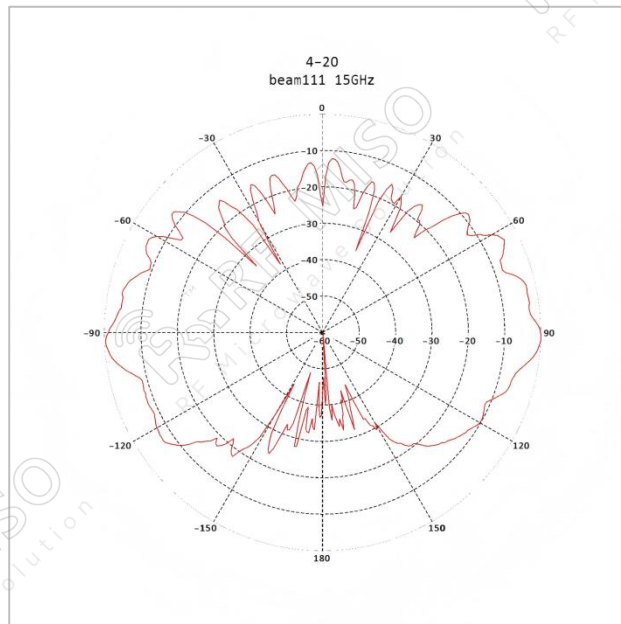

15GHz

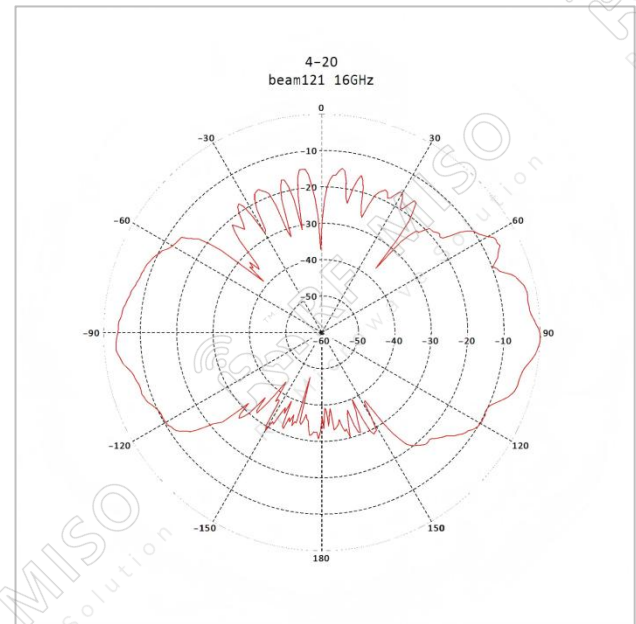

16GHz



Biconical Antenna 1-20 GHz Frequency Range
2 dBi Typ. Gain, Slant polarization

Biconical Antenna Data Sheet

RM-BCA120-2

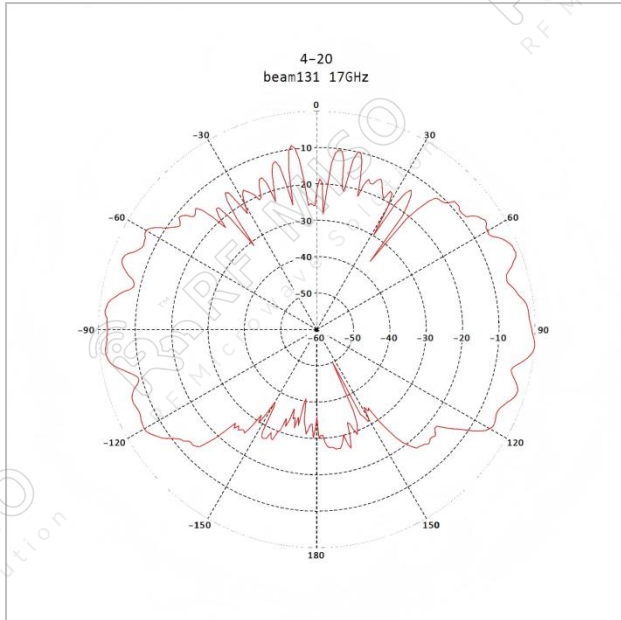

17GHz

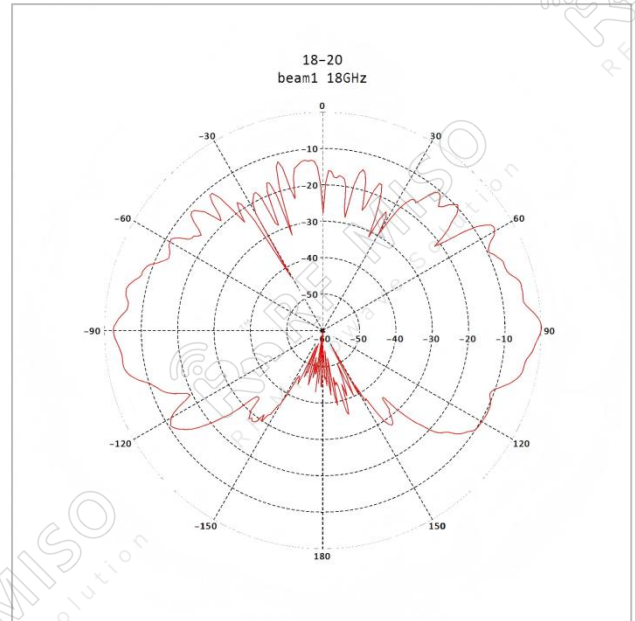

18GHz

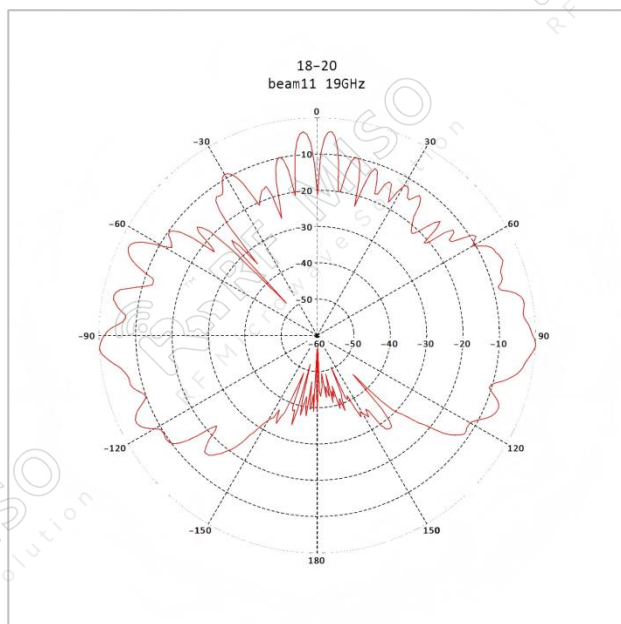

19GHz

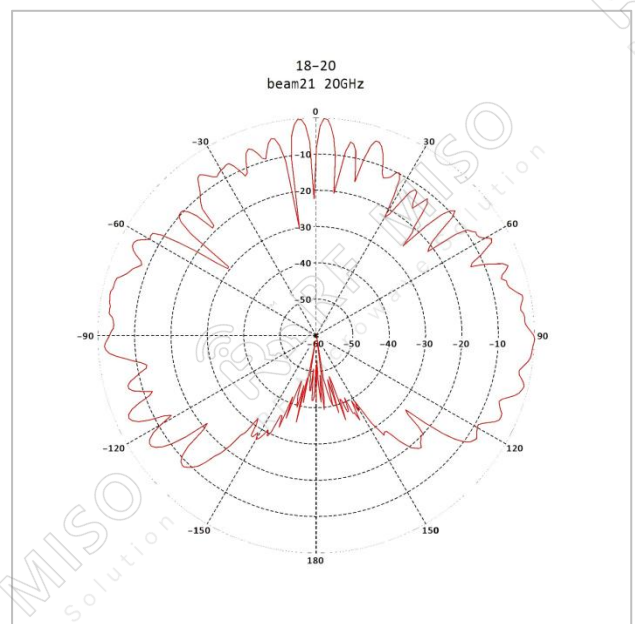

20GHz